

dormakaba 

# PAXOS<sup>®</sup> advance IP

## Operating Manual

---

Manufacturer

**dormakaba Schweiz AG**

Mühlebühlstrasse 23, Postfach

8620 Wetzikon

SWITZERLAND

[www.dormakaba.com](http://www.dormakaba.com)

Sales:



---

This documentation may not be reproduced in any way or otherwise used without the written consent of dormakaba Schweiz AG.

Kaba® and PAXOS® advance are registered trademarks of dormakaba Schweiz AG.

Copyright by dormakaba Schweiz AG 2019

Doc. OM\_PAXOS\_V005\_20190222\_EN

---

# Table of Contents

---

|          |  |           |
|----------|--|-----------|
| <b>1</b> | <b>About this Operating Manual</b>                         | <b>6</b>  |
| 1.1      | To the beginning   | 6         |
| 1.2      | Validity/Limitation  | 6         |
| 1.3      | Target group   | 6         |
| 1.4      | Additional documentation                                   | 6         |
| 1.5      | Information and warning symbols                            | 7         |
| 1.5.1    | Danger to personnel  | 7         |
| 1.5.2    | Danger to property   | 7         |
| 1.5.3    | Other notes  | 7         |
| 1.6      | Marks and definitions in the text                          | 7         |
| <b>2</b> | <b>Safety and Environment</b>                              | <b>8</b>  |
| 2.1      | Intended use   | 8         |
| 2.2      | General  | 8         |
| 2.3      | Personnel qualification                                    | 8         |
| 2.4      | Inadmissible equipment modifications                       | 8         |
| 2.5      | Disposal   | 9         |
| <b>3</b> | <b>Product Description</b>                                 | <b>10</b> |
| 3.1      | Description of the system                                  | 10        |
| 3.2      | Intended purpose   | 12        |
| 3.3      | Technical data   | 13        |
| 3.3.1    | Input unit with keypad                                     | 13        |
| 3.3.2    | Input unit with dial knob                                  | 14        |
| 3.3.3    | Lock   | 15        |
| 3.3.4    | I/O-Box  | 16        |
| 3.3.5    | IP-Box   | 16        |
| 3.4      | Compliance/standards and regulations                       | 17        |
| <b>4</b> | <b>Operation</b>   | <b>18</b> |
| 4.1      | Operating and display elements of the input unit           | 18        |
| 4.1.1    | Operating and display elements of the keypad input unit    | 18        |
| 4.1.2    | Operating and display elements of the dial knob input unit | 19        |
| 4.2      | Waking up the input unit/standard mode display             | 20        |
| 4.3      | Status messages in the standard mode display               | 20        |
| 4.4      | Code input/error messages when entering the code           | 22        |
| 4.4.1    | Code input   | 22        |
| 4.4.2    | Error messages during code input                           | 23        |
| 4.5      | Opening the locks  | 24        |

|          |   |           |
|----------|---|-----------|
| 4.5.1    | Opening the door locks  | 25        |
| 4.5.2    | Opening the inner compartment locks   | 27        |
| 4.6      | Closing the locks   | 29        |
| 4.6.1    | Closing the inner compartment locks   | 29        |
| 4.6.2    | Closing the door locks  | 30        |
| 4.7      | Enabling Fast Locking   | 31        |
| 4.8      | Enabling a Time Lock Delay  | 32        |
| 4.9      | Setting the contrast, brightness and dialog language  | 33        |
| <b>5</b> | <b>Configuring the System</b>   | <b>35</b> |
| 5.1      | Overview of setting parameters  | 35        |
| 5.2      | Code functions  | 37        |
| 5.2.1    | General information on the codes  | 37        |
| 5.2.2    | Standard code types   | 37        |
| 5.2.3    | Code formats  | 40        |
| 5.2.4    | Setting new codes   | 40        |
| 5.2.4.1  | Setting the Opening Code OCa., OCb. and Master Code   | 41        |
| 5.2.4.2  | Defining new codes (e.g. additional Opening Codes, Time Codes, Mutation Codes, Net codes, etc.) | 45        |
| 5.2.5    | Deleting or changing existing codes   | 47        |
| 5.3      | Time functions  | 50        |
| 5.3.1    | General information on the time functions   | 50        |
| 5.3.2    | Setting the current date and time   | 51        |
| 5.3.3    | Setting, changing, deleting a Holiday Locking Period  | 53        |
| 5.3.4    | Setting, changing, deleting a Yearly Locking Period   | 57        |
| 5.3.5    | Setting, changing and deleting a Weekly Locking Period  | 61        |
| 5.3.6    | Setting, changing and deleting a Time Lock Override   | 65        |
| 5.3.7    | Setting, changing and deleting Partial Locking  | 69        |
| 5.3.8    | Setting/disabling Opening Delays  | 73        |
| 5.3.9    | Setting/Disabling Duress Delays   | 75        |
| 5.3.10   | Setting/disabling the Confirmation Window   | 77        |
| 5.3.11   | Setting/disabling the Return Lock   | 79        |
| 5.3.12   | Setting, changing and deleting Summer/Winter Time Changeover                                    | 81        |
| 5.4      | Settings  | 85        |
| 5.4.1    | General information on the settings   | 85        |
| 5.4.2    | Define basic settings for the locks   | 86        |
| 5.4.2.1  | Enabling/disabling Duress Code  | 86        |
| 5.4.2.2  | Setting Fast Locking times  | 88        |
| 5.4.2.3  | Setting a Time Lock Delay   | 90        |
| 5.4.2.4  | Setting the date and time format  | 92        |
| 5.4.2.5  | Setting the Locking Mode  | 94        |
| 5.4.2.6  | Enabling/disabling the Show time lock end   | 96        |

---

|          |   |            |
|----------|---|------------|
| 5.4.2.7  | Enabling/disabling the Remote Lock function                               | 98         |
| 5.4.2.8  | Enabling/disabling Parallel Mode  | 100        |
| 5.4.2.9  | Enabling/disabling Dual Mode  | 102        |
| 5.4.2.10 | Setting the Maximum Open Period   | 104        |
| 5.4.3    | Defining basic settings for the input unit                                | 106        |
| 5.4.3.1  | Setting the dialog language, brightness and contrast of the display       | 106        |
| 5.4.3.2  | Setting the signal volume   | 108        |
| 5.4.3.3  | Setting the content of the battery compartment                            | 109        |
| <b>6</b> | <b>Querying System Information</b>  | <b>111</b> |
| 6.1      | Querying system information over the Info menu                            | 111        |
| 6.1.1    | Accessing the Info menu   | 111        |
| 6.1.2    | Querying the system settings  | 112        |
| 6.1.3    | Querying lock information   | 113        |
| 6.1.4    | Querying information of an input unit                                     | 114        |
| 6.1.5    | Querying information on the I/O-Box                                       | 115        |
| 6.1.6    | Querying information on the IP-Box  | 116        |
| 6.2      | Querying locking periods  | 117        |
| <b>7</b> | <b>Maintenance</b>  | <b>118</b> |
| 7.1      | Notes on maintenance  | 118        |
| 7.2      | Cleaning the input unit   | 118        |
| 7.3      | Replacing the batteries/dormakaba rechargeable battery pack, Battery code | 118        |
| <b>8</b> | <b>Operating errors</b>   | <b>121</b> |
| 8.1      | Error messages / Troubleshooting  | 121        |
| 8.2      | Notes on troubleshooting  | 124        |
| 8.3      | Customer Service  | 124        |
| <b>9</b> | <b>Appendix</b>   | <b>125</b> |
| 9.1      | Menu overviews for input unit   | 125        |
| 9.1.1    | Operator menu   | 125        |
| 9.1.2    | Info menu   | 126        |
| 9.2      | Factory code / Demonstration code list                                    | 127        |
| 9.2.1    | Factory code  | 127        |
| 9.2.2    | Demonstration code list   | 127        |

# 1 About this Operating Manual

## 1.1 To the beginning

The fully redundant electronic high-security locking system PAXOS advance IP (Paxos advance for short) is designed in accordance with the latest technology and meets all known safety standards. Nevertheless, improper operation of the electronic high-security locking system Paxos advance can lead to material damage or physical injury.

To ensure a safe, proper and economical operation of the electronic high-security locking system Paxos advance, observe and comply with all information and safety instructions in this manual and the instructions for the components that are used together with the locking system.

If you have questions, which are not or insufficiently answered in this Operating Manual, please contact your supplier. They will be glad to assist you.

## 1.2 Validity/Limitation

This manual describes the operation and configuration of the electronic high-security locking system Paxos advance.

The available options (I/O-Box, IP-Box, AS384 Management-Suite Software) are only described insofar as required for the proper operation of the electronic high-security locking system Paxos advance. Further information on the optional AS384 Management-Suite Software can be found in the help function of the software.

## 1.3 Target group

This Operating Manual is intended for highly skilled and trained personnel, which are entrusted with the operation and configuration of the electronic high security locking system Paxos advance.

The description presumes that trained personnel certified by dormakaba Schweiz AG are working on the system and does not replace product training.

## 1.4 Additional documentation

This Operating Manual is supplemented by the Installation Instructions, the Quick Start Guide and the Service Instructions for the electronic high-security locking system Paxos advance.

## 1.5 Information and warning symbols

### 1.5.1 Danger to personnel



#### Risk of explosion!

Indicates potentially dangerous situation that in case of non-compliance may lead to minor injuries.

### 1.5.2 Danger to property



#### CAUTION

Indicates a potentially dangerous situation which, if not heeded, might lead to system damage or have significant impact on the function and/or usage of the system.

### 1.5.3 Other notes



Application instructions with additional information. They ensure that the product and its functions are used optimally.



#### AS384 Management-Suite Software

Refers to the AS384 Management-Suite Software (optional), which allows additional settings and functions.

## 1.6 Marks and definitions in the text

- To enhance readability of the instructions, the “fully redundant electronic high-security locking system PAXOS advance IP” is shortened to “locking system” or “Paxos advance”.
- Cross-references to other chapters with more detailed information about a topic are marked in italics and set in parentheses.  
Example: *(see section 3 “Product Description”)*
- Text appearing in the display of the input unit is placed in quotation marks.  
Example: “Unlocked”
- Keys that need to be pressed are marked in bold capital letters and set in angle brackets (example: <ENTER>).

## **2 Safety and Environment**

### **2.1 Intended use**

The locking system Paxos advance is used for locking and releasing the mechanical locking points of safe doors and inner compartment locks, which are generally operated manually via a bolt-work.

The release (open locks) is only executed after entering one or more of the opening codes on the input unit. The opening of the lock can also be made dependent on time functions and/or external signals.

The locking system Paxos advance must be used only for its intended purpose – blocking and releasing mechanical blocking points of the above-mentioned equipment. Any use beyond this is deemed to be improper. The manufacturer is not liable for any damages that result from such use.

The locking system Paxos advance is intended solely for use in closed rooms.

### **2.2 General**

Any person entrusted with working on the locking system Paxos advance must read and understand this manual before starting work.

Knowledge of the contents of the operating manual is a prerequisite for protecting staff from dangers, avoiding faulty operation and thus operating the system safely and appropriately.

### **2.3 Personnel qualification**

All actions described in this manual must be performed only by well trained and sufficiently qualified personnel. It is assumed that this personnel knows all relevant external and internal regulations that must be observed for the operation of the locking system Paxos advance.

For safety and warranty reasons, further interventions must be performed solely by personnel authorised by the manufacturer.

### **2.4 Inadmissible equipment modifications**

Modifications to the electronic high security locking system Paxos advance are expressly not recommended and can lead to the loss of warranty and certification (e.g. VdS certification) and affect the security of the system.

Defective system components may be replaced only with original parts from your supplier and only by authorized personnel.



## 2.5 Disposal

### Packaging



#### Environmentally-friendly disposal of packaging

The system components are supplied in recyclable packaging. Please do not dispose of packaging in the household waste or the environment, but have them recycled instead.

### System components



#### Do not dispose of system components in the household waste or the environment

At the end of the service life or in case of replacement, the system components must be returned to dormakaba Schweiz AG or taken to a disposal or recycling point, in accordance with the locally applicable regulations. Under no circumstances may system components be disposed of in the environment.

### Batteries/rechargeable batteries



#### No not dispose of used batteries/rechargeable batteries in the household waste or the environment

Used batteries/rechargeable batteries are to be disposed or taken to a recycling point, in accordance with state and local regulations. Under no circumstances may batteries be disposed of in the household waste or the environment.

Carefully store the batteries/dormakaba rechargeable battery packs to be disposed of in order to avoid short circuits, squeezing, or destruction of the battery/rechargeable battery casing.

### 3 Product Description

#### 3.1 Description of the system

##### Basic version

In the basic version, the fully redundant electronic high-security locking system Paxos advance consists of an input unit (with keypad or dial knob), one or more door locks and, optionally, multiple inner compartment locks, which are interconnected via a redundant Bus system. In the basic version, the system is supplied by a battery pack with six alkaline or lithium batteries of type AA. Each of the two redundant door bolt contacts, connected to door lock 1 and each inner compartment lock (customer must install), signal to the system whether the door locks or an inner compartment lock is open or closed.

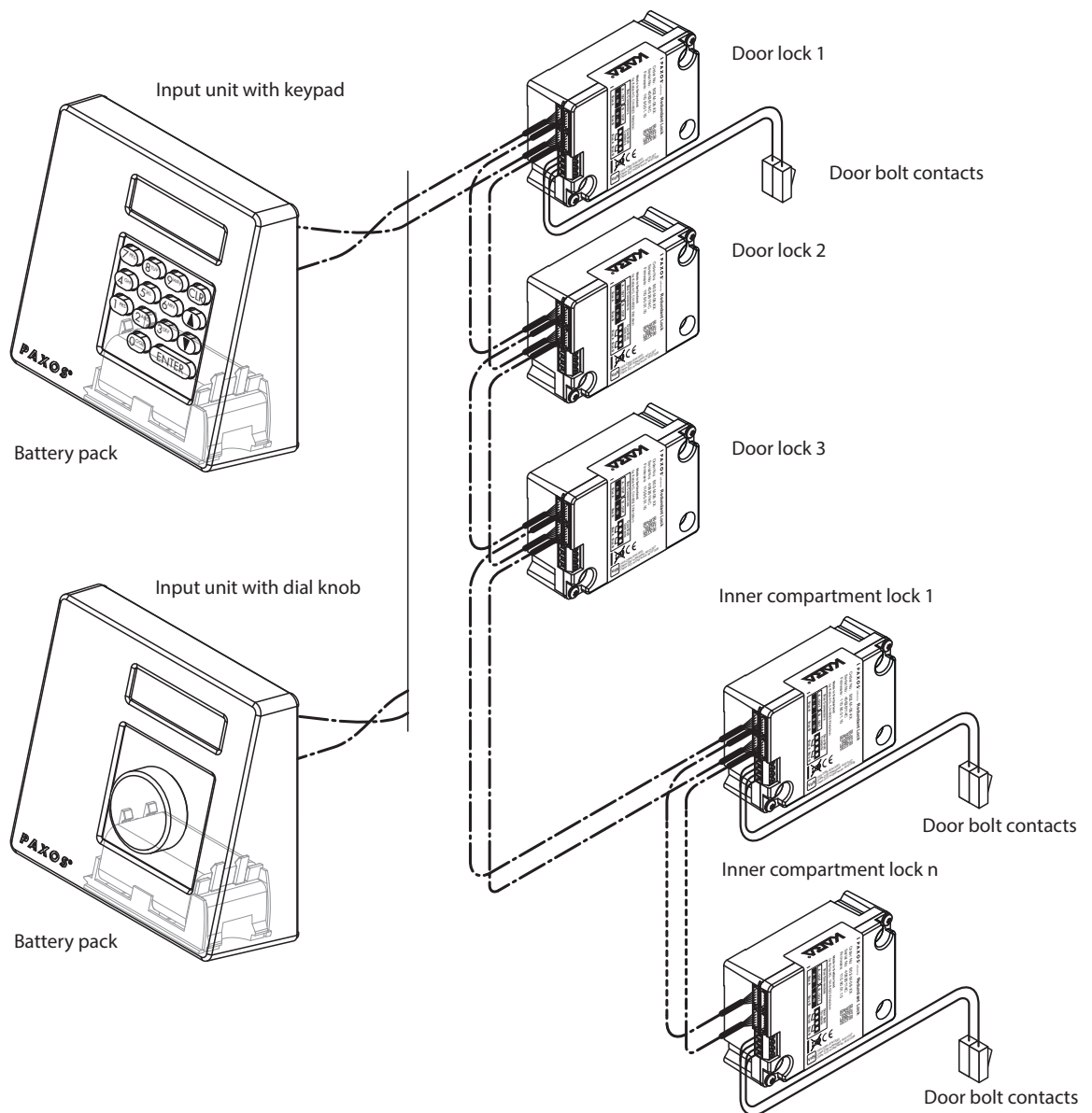

System overview basic version

The locking system Paxos advance provides powerful functions for application in high security areas (e.g. different types of code with different access privileges, dual mode, duress code, opening delay, locking period functions, etc.). In the basic version, operation and configuration of the system take place via the input unit. Optionally, the system can also be programmed and managed via the AS384 Management-Suite Software.

The basic model can be extended optionally with up to two additional input units, and up to three optional I/O-Boxes and an IP-Box. a maximum of 12 system components (locks, input units, I/O-Boxes, IP-Box) can be interconnected over the redundant Bus system.

### Option I/O-Box

The optional I/O-Box is integrated into the locking system via the redundant Bus system.

The I/O-Box features **8 inputs and outputs for enhanced alarm and safety functions**, and terminals for connection of an external voltage source. The function of the inputs and outputs are factory preset and can be assigned individually only with the AS384 Management-Suite Software.

If the I/O-Box is connected to a **non-failsafe power supply**, the battery compartment of the input unit **must necessarily have a battery/rechargeable battery pack**, which ensures voltage supply to the system when the power fails. The input unit control automatically detects whether a battery pack is inserted in the battery compartment and charges it while operating on an external power source.

If the I/O-Box is connected to an uninterruptible power supply (UPS), a battery/rechargeable battery pack does not need to be inserted in the battery compartment of the input device.

### Option IP-Box

The optional IP-Box is integrated into the locking system via the redundant Bus system.

The IP-Box serves as network interface and features **3 inputs and outputs to control additional functions**, and terminals for connection of an external voltage source. The function of the inputs and outputs are factory preset and can be assigned individually only with the AS384 Management-Suite Software.

If the IP-Box is connected to a **non-failsafe power supply**, the battery compartment of the input unit **must necessarily have a battery/rechargeable battery pack**, which ensures voltage supply to the system when the power fails. The input unit control automatically detects whether a battery pack is inserted in the battery compartment and charges it while operating on an external power source.

If the IP-Box is connected to an uninterruptible power supply (UPS), a battery/rechargeable battery pack does not need to be inserted in the battery compartment of the input device.

### Option AS384 Management-Suite Software

The AS384 Management-Suite Software provides access to advanced functions of the locking system Paxos advance (e.g. definition of time-controlled locking periods, setting of codes with individual authorisations, code profiles and code profile groups, reading of audit data as well as export and import of audit files, etc.), thus allowing the creation and management of custom solutions. In addition, multiple Paxos advance locking systems may be managed with the AS384 Management-Suite Software, either via the USB interface or via an IP network.

### Operational modes

The locking system Paxos advance can be operated in two different modes:

- **Stand-alone mode** (code format: **PIN only**, for lock class 4 (EN1300) or D (VdS 2396) the code format is always ID+PIN)  
Configuration of the locking system is done exclusively via the control software of the input unit.
- **Extended mode** (code formats: **PIN only** or **ID+PIN**)  
The configuration of the locking system is done via the optional AS384 Management-Suite Software.

## 3.2 Intended purpose

The locking system Paxos advance serves to block and release mechanical blocking points of secure storage doors and inner compartment locks.

The locking system Paxos advance offers a wide range of high-security applications. It allows the programming of different codes and code combinations, time dependent functions, etc., for accessing and programming the system.

Programming is done via the input unit (stand-alone mode) or via a computer which runs the AS384 Management-Suite Software and is connected by USB cable to the input unit (extended mode) or via network and AS384 Management-Suite Software.

The locking system Paxos advance is especially suitable for applications where high security, multiple users, traceability and flexibility are required. The consistent redundancy of the system components guarantees high reliability of the locking system.

### 3.3 Technical data

#### 3.3.1 Input unit with keypad

|  |   |
|--|---|
| Dimensions (HxWxD)   | 137x135x60 mm   |
| Weight (without batteries/rechargeable batteries and mounting bracket) | 410 g   |
| Material   | ABS injection moulded   |
| Fastening  | With mounting bracket and 2 M6 screws                                       |
| Electrical connection to the locking system                            | Redundant bus cables (Bus a and Bus B)                                      |
| Display  | LCD with backlight, graphic 122 x 32 pixels (2 lines)                       |
| Dialog language  | German, English, French, Italian, Spanish and others                        |
| Input  | Keypad (14 keys)  |
| Identification mark code   | 0...9 and/or A...Z  |
| Number of code positions   | 8 characters/digits   |
| Number of code combinations  | 100'000'000 (100 million)   |
| Batteries  | 6x alkaline or lithium 1,5 V,<br>Type "Minion", "AA", "LR6", "E91" or "AM3" |
| Rechargeable batteries   | Paxos rechargeable battery pack 9V Ni-MH 302011                             |
| Operating voltage  | 9 VDC   |
| Power consumption active / idle  | Max. 13 mA / 20 µA  |
| Overvoltage protection   | Until 10 kV   |
| Electro-magnetic compatibility (EMC)                                   | According to VdS 2110   |
| Permissible temperature range of operation                             | 0 °C ... +50 °C   |
| Permissible temperature range of storage                               | -10 °C ... +70 °C   |
| Permissible ambient humidity   | Max. 75% RH, non-condensing   |
| Certification mark   | CE  |
| Safety class   | B (EN 1300), 2 (VdS 2396), UL   |

### 3.3.2 Input unit with dial knob

|  |  |
|--|--|
| Dimensions (HxWxD)   | 137x135x60 mm  |
| Weight (without batteries/rechargeable batteries and mounting bracket) | 405 g  |
| Material   | ABS injection moulded  |
| Fastening  | With mounting bracket  |
| Electrical connection to the locking system                            | Redundant bus cables (Bus a and Bus B)                                   |
| Display  | LCD with backlight, graphic 122 x 32 pixels (2 lines)                    |
| Viewing angle limitation   | Laterally $\pm 30^\circ$   |
| Dialog language  | German, English, French, Italian, Spanish and others                     |
| Input  | Dial/push knob, specifying a random number                               |
| Identification mark code   | 0...9  |
| Number of code points  | 8 characters   |
| Number of code combinations  | 100'000'000 (100 million)  |
| Batteries  | 6x alkaline or lithium 1,5 V, Type "Minion", "AA", "LR6", "E91" or "AM3" |
| Rechargeable batteries   | Paxos rechargeable battery pack 9V Ni-MH 302011                          |
| Operating voltage  | 9 VDC  |
| Power consumption  | max. 33 mA   |
| Overvoltage protection   | Until 10 kV  |
| Electro-magnetic compatibility (EMC)                                   | According to VdS 2110  |
| Permissible temperature range for operation                            | 0 °C ... +50 °C  |
| Permissible temperature range for storage                              | -10 °C ... +70 °C  |
| Permissible ambient humidity   | max. 75% RH, non-condensing  |
| Certification mark   | CE   |
| Safety class   | C/D (EN 1300), 3/4 (VdS 2396), UL  |

### 3.3.3 Lock

|   |   |
|---|---|
| Dimensions (HxWxD)                                  | 85.0 x 60.4 x 30.9 mm   |
| Weight  | 440 g   |
| Material  | Zamak die-cast zinc   |
| Fastening   | 3 screws M6   |
| Electrical connection to the locking system         | Redundant bus cables (Bus a and Bus B)  |
| Fastening carrier adapter to boltwork               | 1 screw M5 or 2 screws M4   |
| Boltwork  | Adjustable 8.7, 12, 14 or 15 mm   |
| Bolt adjustment force nominal                       | 30 N (in both directions)   |
| Bolt counter force in adjustment direction (static) | ≥ 1000 N  |
| Code storage  | Flash (power failure protected)   |
| Operating voltage                                   | 9 VDC   |
| Standby current active/idle                         | 11 mA / approx. 20 µA   |
| Maximum motor activation current                    | 660 mA  |
| Overvoltage protection                              | Until 10 kV   |
| Electro-magnetic compatibility (EMC)                | According to VdS 2110   |
| Permissible temperature range for operation         | 0 °C ... +50 °C   |
| Permissible temperature range for storage           | -10 °C ... +70 °C   |
| Permissible ambient humidity                        | Max. 75% RH, non-condensing   |
| Certification mark                                  | CE  |
| Safety class  | <p>B/C/D (EN 1300), 2/3/4 (VdS 2396):</p> <ul style="list-style-type: none"> <li>- with Keypad Input Unit: B (EN 1300), 2 (VdS 2396)</li> <li>- with Dial Knob Input Unit: C (EN 1300), 3 (VdS 2396)</li> <li>- with Dial Knob Input Unit: D (EN 1300), 4 (VdS 2396)</li> </ul> <p>- UL certified when lock distance to cable hole is at least 15 cm.</p> <p>Note: The audit features, the software features, features associated with peripheral devices and systems, optional interconnect devices and their associated features, features involving the use of user keys, the duress feature, monitoring features, remote features, one time code functionality and other additional features have not been evaluated by UL.</p> |

### 3.3.4 I/O-Box

|   |   |
|---|---|
| Dimensions (HxWxD)                          | 117 x 80,0 x 33,5 mm                            |
| Weight                                      | 186 g   |
| Material housing                            | Aluminium                                       |
| Fastening                                   | 4 screws M5                                     |
| Electrical connection to locking system     | Redundant bus cables (Bus a and Bus B)          |
| Terminals                                   | for wire cross sections up to 1 mm <sup>2</sup> |
| Inputs                                      | 8   |
| Outputs                                     | 8   |
| Interface                                   | RS232   |
| Connection of external power supply         | 12...24 VDC, 1 A                                |
| Operating voltage                           | 12 VDC  |
| Power consumption                           | Max. 300 mA                                     |
| Overvoltage protection                      | Until 10 kV                                     |
| Electro-magnetic compatibility (EMC)        | According to VdS 2110                           |
| Permissible temperature range for operation | 0 °C ... +50 °C                                 |
| Permissible temperature range for storage   | -10 °C ... +70 °C                               |
| Permissible ambient humidity                | Max. 75% RH, non-condensing                     |
| Certification mark                          | CE  |

### 3.3.5 IP-Box

|   |   |
|---|---|
| Dimensions (H x W x D)                        | 120 x 100 x 36 mm                               |
| Weight  | 410 g   |
| Material housing                              | Sheet metal, galvanized                         |
| Fastening                                     | 4 M5 screws                                     |
| Electrical connection with the locking system | Redundant bus cables (Bus A and Bus B)          |
| Terminals                                     | for wire cross sections up to 1 mm <sup>2</sup> |
| Inputs  | 3   |
| Outputs                                       | 3   |
| Interface                                     | Ethernet RJ45 10/100BaseT                       |
| Connection of external power supply           | 12...24 VDC, 1 A                                |
| Operating voltage                             | 12 VDC  |
| Power consumption                             | Max. 300 mA                                     |
| Overvoltage protection                        | Up to 10 kV                                     |
| Electro-magnetic compatibility (EMC)          | According to VdS 2110                           |
| Permissible temperature range for operation   | 0 °C ... +50 °C                                 |
| Permissible temperature range for storage     | -10 °C ... +70 °C                               |
| Permissible ambient humidity                  | Max. 75 %RH, non-condensing                     |
| Certification mark                            | CE  |



### **3.4 Compliance/standards and regulations**

The Declaration of Conformity is delivered in a separate document.

The fully redundant electronic high-security locking system Paxos advance complies with the standards and regulations in accordance with the information provided in the Technical Data (see *section 3.3 "Technical data"*).

## 4 Operation

### 4.1 Operating and display elements of the input unit

#### 4.1.1 Operating and display elements of the keypad input unit

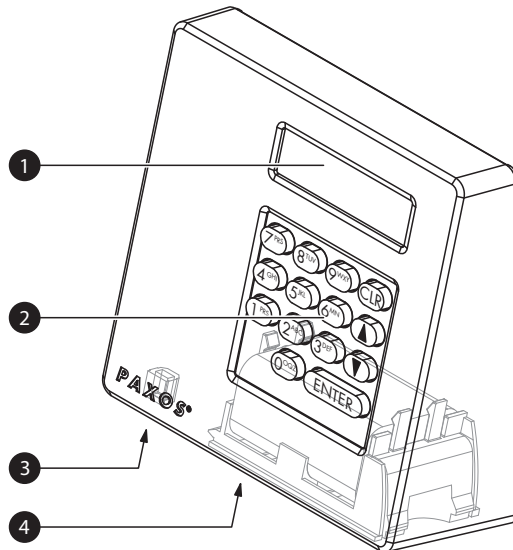

- 1 Two-line liquid crystal display (LCD)
- 2 Keypad with 10 numeric and 4 function keys
- 3 USB port (connection to computer with programming or audit software)
- 4 Battery compartment

Keypad input unit

#### Key functions

| Keys |   | Function  |
|------|---|---|
|      | Press briefly   | <ul style="list-style-type: none"> <li>– Confirming input</li> <li>– Calling the user menu from the standard mode display</li> </ul>              |
|      | Press briefly   | <ul style="list-style-type: none"> <li>– Deleting input</li> <li>– Aborting a function</li> <li>– Returning to the previous menu level</li> </ul> |
|      | Press briefly   | <ul style="list-style-type: none"> <li>– Selecting the next menu option</li> <li>– Selecting the next input value</li> </ul>                      |
|      | Press briefly   | <ul style="list-style-type: none"> <li>– Selecting the previous menu option</li> <li>– Returning to the previous input value</li> </ul>           |
|      | Press briefly   | Input of numbers  |
|      | Press and hold down key. Release key as soon as the info menu appears | Calling Info menu   |



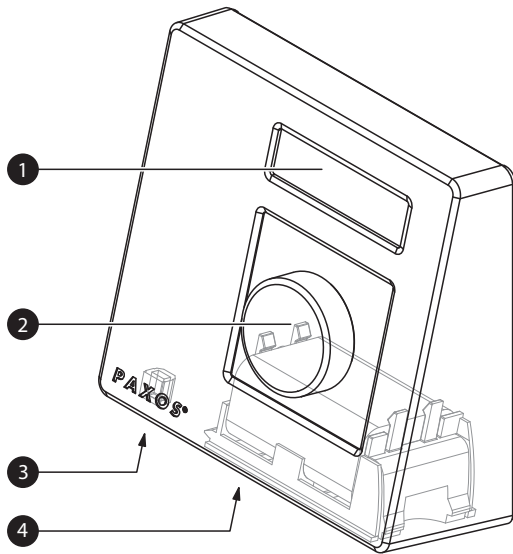

### 4.1.2 Operating and display elements of the dial knob input unit



- 1 Two-line liquid crystal display (LCD)
- 2 Dial knob
- 3 USB port (connection to computer with programming or audit software)
- 4 Battery compartment

Dial knob input unit

#### Functions of the dial knob

| Dial knob   |   | Function   |
|---|---|--|
|  | Press dial knob briefly.  | <ul style="list-style-type: none"> <li>– Confirming input</li> <li>– Calling the user menu from the standard mode display</li> </ul>   |
|  | Press dial knob > 1.5 seconds.  | <ul style="list-style-type: none"> <li>– Deleting input</li> <li>– Aborting a function</li> <li>– Returning to the previous menu level</li> </ul>  |
|  | Turn dial knob left or right.   | <ul style="list-style-type: none"> <li>– Selecting the next or previous menu option</li> <li>– Selecting the next or previous input value</li> <li>– Increasing or decreasing the value displayed</li> </ul> |
|  | Press and hold down key. Release dial knob as soon as the info menu appears | Calling Info menu  |

## 4.2 Waking up the input unit/standard mode display

### Waking up the display of the input unit



The display of the input unit switches **automatically off** after **15 seconds without action**. To wake up the display, press any key on the keypad input unit or press briefly the knob of the dial knob input unit.

Assuming the locking system has been put into operation and addressed properly (see installation instructions), the standard operating mode display appears after waking up the input unit. In the standard mode display, the current date, current time, and the current status of the locking system is shown (e.g. state "Secured").

|                             |
|-----------------------------|
| 22.11.2012 07:53<br>Secured |
|-----------------------------|

- If another status message is displayed, please follow the instructions in *section 4.3 "Status messages in the standard mode display"*.
- If the display remains blank or an error message is displayed, please follow the instructions in *section 8 "Operating errors"*.

## 4.3 Status messages in the standard mode display

|  |  |  |  |
|--|--|--|--|
| <table border="1"> <tr> <td>22.11.2012 07:39<br/>Unlocked</td> </tr> </table>  | 22.11.2012 07:39<br>Unlocked   | <p>The door locks are unlocked and the boltwork is open.</p> <p>By briefly pressing the <b>&lt;ENTER&gt;</b> key or briefly pressing the dial knob you can access the user menu "Unlocked".</p>                      |  |
| 22.11.2012 07:39<br>Unlocked   |  |  |  |
| <table border="1"> <tr> <td> Locks are open,<br/>open bolt</td> </tr> <tr> <td>01.01.2012 00:03<br/>Open bolt</td> </tr> </table> |  Locks are open,<br>open bolt | 01.01.2012 00:03<br>Open bolt  | <p>The door locks are open and the boltwork is closed.</p> <p>After opening the door locks, the message "Locks are open, open bolt" appears for about 5 seconds. Then a sound signal and the message "Open bolt" indicates that you should open the boltwork. If the boltwork is not opened within a certain time, the door locks will be closed automatically (with "Locking mode Automatic") or the message "Close with ENTER" appears (with "Locking mode Manual").</p> |
|  Locks are open,<br>open bolt   |  |  |  |
| 01.01.2012 00:03<br>Open bolt  |  |  |  |
| <table border="1"> <tr> <td>28.12.2012 11:38<br/>Locked</td> </tr> </table>  | 28.12.2012 11:38<br>Locked   | <p>The safe door is partly locked. The last door lock and boltwork are closed.</p> <p>By briefly pressing the <b>&lt;ENTER&gt;</b> key or briefly pressing the dial knob you can access the user menu "Secured".</p> |  |
| 28.12.2012 11:38<br>Locked   |  |  |  |
| <table border="1"> <tr> <td>22.11.2012 07:53<br/>Secured</td> </tr> </table>   | 22.11.2012 07:53<br>Secured  | <p>The boltwork and the door locks are closed.</p> <p>By briefly pressing the <b>&lt;ENTER&gt;</b> key or briefly pressing the dial knob you can access the user menu "Secured".</p>                                 |  |
| 22.11.2012 07:53<br>Secured  |  |  |  |
| <table border="1"> <tr> <td>&gt;&gt;&gt; 28.12.2012 11:50<br/>Time lock</td> </tr> <tr> <td>28.12.2012 11:43<br/>Time lock</td> </tr> </table>   | >>> 28.12.2012 11:50<br>Time lock  | 28.12.2012 11:43<br>Time lock  | <p>The locking system is locked via one of the locking time functions (e.g. fast locking). The door locks cannot be opened until the locking time has expired. The date and time of the end of the locking time are displayed.</p> <p>By briefly pressing the <b>&lt;CLR&gt;</b> key or by pressing the dial knob &gt;1.5 seconds, the current date and current time are displayed for about 5 seconds.</p>  |
| >>> 28.12.2012 11:50<br>Time lock  |  |  |  |
| 28.12.2012 11:43<br>Time lock  |  |  |  |





|   |  |
|---|--|
| <p>27.12.2012 13:00<br/>Not addressed</p>   | <p>The locking system has not been addressed yet.<br/>If this message is displayed, the locking system must first be addressed before it can be used. Please refer to the instructions in the Paxos advance Installation Instructions.</p>   |
| <p>Batt. comp. opened,<br/>Batteries inside</p> <p>22.11.2012 10:20<br/>Battery code</p> <p>Code Lock 1<br/>-----</p> | <p>The battery compartment has been opened since the last operation. The system is locked.<br/>Confirm this message by pressing the &lt;ENTER&gt; key and briefly pressing the dial knob.<br/>Confirm this message by pressing the key &lt;ENTER&gt; key and briefly pressing the dial knob.<br/>Enter a valid code for lock 1 and confirm the code (see section 4.4 "Code input/error messages when entering the code"). The locking system is then released again.</p> |
| <p>Batt. Comp. is open</p>  | <p>This message appears if the battery compartment is open while waking up the input unit. Insert the battery compartment.</p>   |
| <p>Max. door open time<br/>Close door</p>   | <p>This message appears when the function Maximum Open Period is enabled and the specified maximum open time of the secure storage door has been exceeded. Close the secure storage door.</p>  |
| <p>28.12.2012 12:24<br/>Remote Disabled</p>   | <p>The locking system is locked via the remote lock function. The door locks can not be opened until the remote locking is deactivated again.</p>  |

## 4.4 Code input/error messages when entering the code





### 4.4.1 Code input

The opening of the locks and all security-relevant configuration settings of the locking system Paxos advance are protected from unauthorized access by codes (formed from digits 0 to 9). The locking system Paxos advance recognizes five different types of code (master code, mutation code, time code, net code and port code) with different access rights (see section 5.2 "Code functions").

In the following, the general procedure for entering the code from the keypad input unit and the dial knob input unit is shown (8-digit unlocking code for lock 1 "13617689" is to be entered).

| Keypad input unit                  |                                   | Dial knob input unit    |  |
|------------------------------------|-----------------------------------|-------------------------|--|
| Code Lock 1<br>-----               |                                   | Code Lock 1<br>19-----  | Random number for the digits 1 and 2 of the code is displayed.   |
| Code Lock 1<br>*------             | (1 <sup>PRE</sup> )               | Code Lock 1<br>13-----  |  Change random number by turning the dialling knob to the value of the digits 1 and 2 of the code and then confirm by pressing the knob.        |
| Code Lock 1<br>**------            | (3 <sup>DEF</sup> )               | Code Lock 1<br>**80---- | Random number for the digits 3 and 4 of the code is displayed.   |
| Code Lock 1<br>***-----            | (6 <sup>MAX</sup> )               | Code Lock 1<br>**61---- |  Change random number by turning the dialling knob to the value of the digits 4 and 4 of the code and then confirm by pressing the knob.      |
| Code Lock 1<br>****-----           | (1 <sup>PRE</sup> )               | Code Lock 1<br>****57-- | Random number for the digits 5 and 6 of the code is displayed.   |
| Code Lock 1<br>*****--             | (7 <sup>PRE</sup> )               | Code Lock 1<br>****76-- |  Change random number by turning the dialling knob to the value of the digits 5 and 6 of the code and then confirm by pressing the knob.      |
| Code Lock 1<br>*****--             | (6 <sup>MAX</sup> )               | Code Lock 1<br>*****81  | Random number for the digits 7 and 8 of the code is displayed.   |
| Code Lock 1<br>*****--             | (8 <sup>MAX</sup> )               | Code Lock 1<br>*****89  |  Change random number by turning the dialling knob to the value of the digits 7 and 8 of the code and then confirm by pressing the dial knob. |
| Code Lock 1<br>*****+<br><br>ENTER | (9 <sup>MAX</sup> )<br>+<br>ENTER |                         |  |

#### 4.4.2 Error messages during code input

|  |  |
|--|--|
|  Code too short       | This message appears when the code that you have entered has less than 8 digits. Re-enter a valid code.  |
|  Entry deleted        | This message appears when you have aborted the code input with the <CLR> key or by pressing the dial knob >1.5 seconds. Re-enter a valid code.         |
|  Wrong code!          | This message appears when you have entered an invalid code. Re-enter a valid code.   |
|  Code not authorized! | This message appears when you have entered a valid code but you have no rights for the respective task. Re-enter a valid code for the respective task. |

## 4.5 Opening the locks



Note the following:

- To open a lock you need one or two (Dual Mode) valid opening codes for the corresponding lock.
- When an incorrect code is repeatedly entered when opening a lock, the locking system is blocked for a certain time. Following penalty times are applied:

| Number of consecutive incorrect code entries | Penalty blocking time |
|--|-----------------------|
| 5  | 6 minutes             |
| +1 (6th incorrect code)                      | 6 minutes             |
| +1 (7th incorrect code)                      | 6 minutes             |
| +1 (8th incorrect code)                      | 6 minutes             |
| +1 (9th incorrect code)                      | 20 minutes            |
| +1 (10th incorrect code)                     | 20 minutes            |
| +1 (11th incorrect code)                     | 20 minutes            |

- If the Duress function is enabled, you can enter a Duress Code to open the lock in the event of a threat. The lock will open as usual according to the defined delay times, but a duress alarm will also be triggered.

The Duress Code is formed by increasing the last digit of the Opening Code by 3 (examples: Opening Code "13658792 -->Duress Code "13658795", Opening Code"13658799 -->Duress Code"13658702", Opening Code"13658797 -->Duress Code"13658700" - there is no transfer to the third last digit). **Important:** With the AS384 Management-Suite Software, the structure of the Duress Code can be modified. As standard the Duress Code is activated and set to opening code+3.

- In Parallel Mode enabled, the Opening Codes for all door locks are identical. If door lock 1 with the Opening Code OCa1 is opened with enabled Parallel Mode, all valid Opening Codes can be used for the second door lock, except OCa1. For opening any further door locks, all valid Opening Codes can be used, except the previously used Opening Codes. The Parallel Mode is only valid for the door locks. Inner compartment locks can not be operated in Parallel Mode.
- If a non-return time delay, a fast locking period or a holiday, weekly or yearly locking period is active the display does not show "Open / Code Lock x" if the <Enter> key is pressed. With the user profile editor of the AS384 Management-Suite Software you can give a user the right to interrupt a locking period. To be able to open the locks during an active locking period you have to open the Service menu. In the Service menu select "Select lock -> Lock x -> Open with x" in order to open the lock.



### 4.5.1 Opening the door locks

**Authorization: Valid Opening Code or two valid Opening Codes for Dual Mode**

**Requirement: System status "Secured"** (door locks and door bolt closed)

To open the door locks (e.g. safe door with 2 locks) proceed as follows:



The process for opening the door locks is dependent on the configuration of the system. In the following opening sequence, displays and entries that appear only when the system is accordingly configured are shown with a **grey background**.

|   |  |
|---|--|
| <p>1. Wake up display (if necessary) and access the menu.</p> |  |
| <p>2. Confirm menu option "Open".</p>                         |  |

#### Open door lock 1

|   |  |
|---|--|
| <p>3. Activate code input (door lock 1).<br/>Note: This step is not mandatory. You can also start with code entry for door lock 1, the code input window will appear automatically (see point 4).</p>   |  |
| <p>4. Enter and confirm a valid Opening Code for door lock 1.</p>   |  |
| <p>This code entry window appears only if Dual Mode is enabled for door lock 1, or the And-codes are enabled (OCa1&amp; or OCa2&amp;) for the Opening Codes OCa1 and OCb2.</p> <p>5. Enter a valid second Opening Code for door lock 1 and confirm.</p> |  |

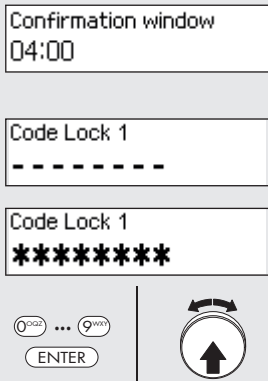
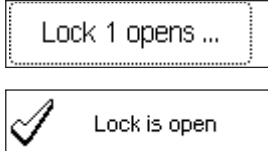
|  |  |
|--|--|
| <p>If an Opening Delay has been defined for door lock 1, the Opening Delay window appears. The time remaining until the lock can be opened is displayed.</p> <p>Note: In extended mode, the opening delay period can be set to "count down", "count up" or "off (do not count)" via the AS384 Management-Suite Software.</p> |   |
| <p>If the Confirmation function is activated for door lock 1, the Confirmation Window appears. a new valid Opening Code of door lock 1 must be entered within the displayed confirmation time.</p> <p>6. Enter and confirm a valid Opening Code (Confirmation Code) for door lock 1.</p>                                     |   |
| <p>Door lock 1 opens.</p> <p>Door lock 1 is opened.</p>  |  |

**Opening door lock 2**

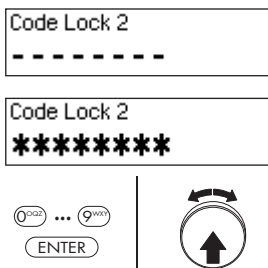
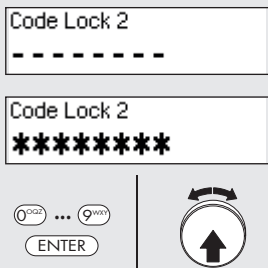
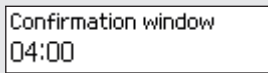
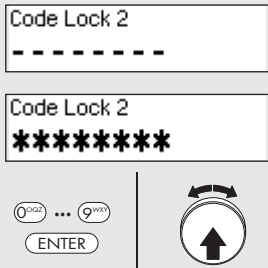
|   |   |
|---|---|
| <p>7. Enter and confirm a valid Opening Code for door lock 2.</p>   |  |
| <p>This code entry window appears only if Dual Mode is enabled for door lock 2, or the And-codes are enabled (OCa1&amp; or OCa2&amp;) for the Opening Codes OCa1 and OCb2.</p> <p>8. Enter a valid second Opening Code for door lock 2 and confirm.</p> |  |
| <p>If the Confirmation function is activated for door lock 2, the Confirmation Window appears. a new valid Opening Code of door lock 2 must be entered within the displayed confirmation time.</p>  |  |
| <p>9. Enter and confirm a valid Opening Code (Confirmation Code) for door lock 2.</p>   |  |

|  |  |
|--|--|
| Door lock 2 opens.   |  |
| Door lock 2 is opened.   |  |
| All door locks are open. The door bolt must be opened within one minute, otherwise the locks will automatically close again. |  |
| 10. Open door bolt.  |  |
| The container door is unlocked (door locks open and boltwork unlocked).  |  |









### 4.5.2 Opening the inner compartment locks

**Authorization:** Valid Opening Code or two valid Opening Codes for Dual Mode

**Requirement:** System status “Unlocked” (door locks and door bolt open)

To open the inner compartment locks, proceed as follows:

|  |  |
|--|--|
| 1. Wake up display (if necessary) and access the menu.     |  |
| 2. Select and confirm the menu option “Open inner cabinet” |  |
| 3. Select menu option “Open inner cabinet”.                |  |
| 4. Select the inner cabinet you wish to open.              |  |

|   |   |   |
|---|---|---|
| <p>5. Activate code entry for the selected inner compartment lock.</p> <p>Note: This step is not mandatory. You can also start immediately with code input for door lock 1, the code input window will appear automatically (see point 6).</p>  |    |    |
| <p>6. Enter valid Opening Code for the selected inner compartment lock and confirm.</p>   | <div style="border: 1px solid black; padding: 2px;">Code Inner cabinet 1<br/>-----</div> <div style="border: 1px solid black; padding: 2px;">Code Inner cabinet 1<br/>*****</div>    |    |
| <p>This code entry window appears only if Dual Mode is enabled for the selected inner compartment lock, or the And-codes are enabled (OCa1&amp; or OCa2&amp;) for the Opening Codes OCa1 and OCb2.</p> <p>7. Enter a valid second Opening Code for the selected inner compartment lock and confirm.</p> | <div style="border: 1px solid black; padding: 2px;">Code Inner cabinet 1<br/>-----</div> <div style="border: 1px solid black; padding: 2px;">Code Inner cabinet 1<br/>*****</div>    |    |
| <p>If an Opening Delay is defined for door lock 1, the Opening Delay window appears. The time remaining until the lock can be opened is displayed.</p>  | <div style="border: 1px solid black; padding: 2px;">Time Delay<br/>00:07</div>  |   |
| <p>If the Confirmation function is activated for the selected inner compartment lock, the Confirmation Window appears. Within the displayed confirmation time, a valid Opening Code for the selected inner compartment lock must be entered.</p>  | <div style="border: 1px solid black; padding: 2px;">Confirmation window<br/>04:00</div>   |   |
| <p>8. Enter valid Opening Code (confirmation code) for the selected inner compartment lock and confirm.</p>   | <div style="border: 1px solid black; padding: 2px;">Code Inner cabinet 1<br/>-----</div> <div style="border: 1px solid black; padding: 2px;">Code Inner cabinet 1<br/>*****</div>  |  |
| <p>Inner compartment lock opens.</p>  | <div style="border: 1px solid black; padding: 2px;">Inner cabinet 1<br/>opens ...</div>   |   |
| <p>Inner compartment lock is opened.</p>  | <div style="border: 1px solid black; padding: 2px;">  Inner cabinet is open         </div>   |   |
| <p>The unit will automatically return to the standard mode display.</p>   | <div style="border: 1px solid black; padding: 2px;">22.11.2012 07:39<br/>Unlocked</div>   |   |

## 4.6 Closing the locks

### 4.6.1 Closing the inner compartment locks

**Authorization:** No code needed

**Requirement:** System status **"Unlocked"** (door locks and door bolt open)

To close the inner compartment locks, proceed as follows:

|  |  |
|--|--|
| <p>1. Close door bolt of the inner compartment lock.</p> <p>The inner compartment lock closes automatically.</p> <p>The inner compartment is closed.</p> | <div style="border: 1px dashed black; padding: 5px; margin-bottom: 5px;">             Inner cabinet 1<br/>             closes ...         </div> <div style="border: 1px solid black; padding: 5px;">  Inner cabinet is closed         </div> |
| <p>The unit will automatically return to the standard mode display.</p>  | <div style="border: 1px solid black; padding: 5px;">             22.11.2012 07:39<br/>             Unlocked         </div>   |

### 4.6.2 Closing the door locks

**Authorization: No code needed**

**Requirement: System status "Unlocked"** (door locks and door bolt open)



The procedure for closing the inner compartment locks depends on the setting of the Locking Mode. In the subsequent locking process, displays and entries that only appear if the corresponding door lock is accordingly configured via Locking Mode are shown with a **grey background**.

If **Partial Locking** is active, only the **last door** is locked during the closing process.

To close the door locks (e.g. doors with 2 locks) proceed as follows:

|   |  |
|---|--|
| 1. The secure storage door and door bolt close.   |  |
| This indicator appears only when the function "Confirm with ENTER" is enabled in Locking Mode.  |  |
| 2. Confirm closing.   |  |
| Door lock 2 closes.   |  |
| Door lock 2 is closed.  |  |
| Door lock 1 closes.   |  |
| Door lock 1 is closed.  |  |
| The unit will automatically return to the standard mode display. The locking system is secured. |  |

## 4.7 Enabling Fast Locking

The function "Fast Locking" allows the immediate activation of a locking period. After closing, the lock can not be opened until the pre-defined time has elapsed.

Example: For shorter business hours before public holidays, this allows bridging the time until the start of regular locking periods. Fast Locking can be enabled both in the Unlocked and Secured menu.

**Authorization:** Any code from lock 1 (except disabled codes)

**Requirement:** System status 'Unlocked' (door locks and door bolt open) or system status "Secured" (door locks and door bolt closed) as well as activated "Fast Locking" function (see section 5.4.2.2 "Setting Fast Locking times")



Fast Locking is not based on the date/time setting. Therefore, Fast Locking cannot be bypassed by changing the date/time setting after activation.

The menu option Fast Locking appears only if the Fast Locking function is enabled in the settings for lock 1 (Fast Locking time > 0 hours). Ex factory Fast Locking is set to 000, i.e. deactivated.

To activate Fast Locking, proceed as follows:

|  |  |
|--|--|
| <p>1. Wake up display (if necessary) and access the menu.</p>  |  |
| <p>2. Select and confirm the menu option "Imm. Time Lock".</p>   |  |
| <p>3. Enter and confirm a valid code for door lock 1.</p>  |  |
| <p>4. Adjust and confirm the fast locking time.<br/>Setting range: 000:01...144.00 (hhh:mm)</p>  |  |
| <p>5. The secure storage door and door bolt close. The door locks close automatically or after confirmation of the locking process (see section 4.6.2 "Closing the door locks").</p> |  |

After return to standard mode display, the status indicator shows that a locking period is active. The door locks cannot be opened until the locking time has elapsed. The date and time of the end of the locking time are displayed.

By briefly pressing the <CLR> key or by pressing the dial knob >1.5 seconds, the current date and current time are displayed for about 5 seconds.

|                                   |
|-----------------------------------|
| >>> 28.12.2012 11:50<br>Time lock |
| 28.12.2012 11:43<br>Time lock     |

### 4.8 Enabling a Time Lock Delay

The function "Time Lock Delay" immediately activates a set period of time, during which the start of the next locking period (week, year, or holiday period) is suppressed. After the Time Lock Delay has elapsed, the regular locking period is active. Time Lock Delay can be set and activated both in the Unlocked and Secured menu.

Example: For longer business hours in special sales days, the time until the start of the regular locking period can be postponed.

**Authorization: Any code from lock 1 (except disabled codes)**

**Requirement: System status 'Unlocked'** (door locks and door bolt open) or **system status "Secured"** (door locks and door lock closed)



Time Lock Delay is not based on the date/time setting. Therefore, Time Lock Delay can be bypassed by changing the date/time setting after activation.

The menu option Time Lock Delay appears only if the Time Lock Delay function is enabled in the settings for lock 1 (Time Lock Delay > 0 hours). Ex factory Time Lock Delay is set to 000, i.e. deactivated.

To activate Time Lock Delay, proceed as follows:

|   |  |
|---|--|
| <p>1. Wake up display (if necessary) and access the menu.</p>     |  |
| <p>2. Select and confirm the menu option "Delay Time Lock".</p>   |  |
| <p>3. Enter and confirm a valid Opening code for door lock 1.</p> |  |

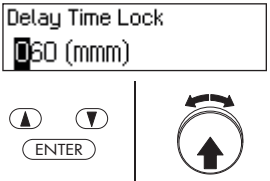
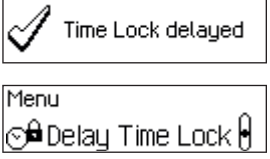

|  |   |
|--|---|
| <p>4. Adjust the delay time and confirm.<br/>Setting range: 1...240 minutes</p>  |  |
| <p>The Time Lock Delay is stored and the delay time immediately starts to run.<br/><br/>The unit returns automatically to the menu option "Delay Time Lock".</p> |  |

### 4.9 Setting the contrast, brightness and dialog language

The contrast and lighting of the display as well as the dialog language can be individually adjusted at any time by all users both in the Unlocked and Secured menu.

**Authorization: No code needed**

**Requirement: System status 'Unlocked'** (door locks and door bolt open) or **system status "Secured"** (door locks and door bolt closed)

To set the contrast, brightness and dialog language, proceed as follows:

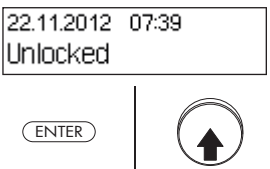
|   |   |
|---|---|
| <p>1. Wake up display (if necessary) and access the menu.</p> |  |
|---|---|

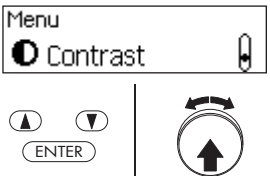
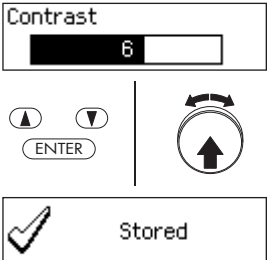

#### Adjusting the contrast

|  |   |
|--|---|
| <p>2. Select and confirm the menu option "Contrast".</p>   |  |
| <p>3. Adjust and confirm desired contrast.<br/>Setting range: 1 (minimum contrast)...10 (maximum contrast)<br/><br/>The setting is stored.</p> |  |

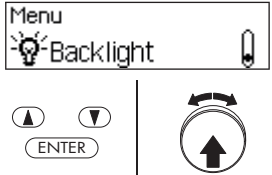
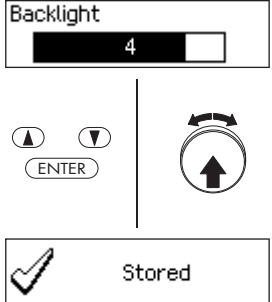
**Setting the brightness**

|   |   |
|---|---|
| <p>4. Select and confirm the menu option "<b>Backlight</b>".</p>  |  |
| <p>5. Set the desired brightness of the backlight or turn off the backlight and confirm.<br/>Setting range: Off (lighting off) or 1 (minimum brightness)...5 (maximum brightness)</p> <p>The setting is stored.</p> |  |

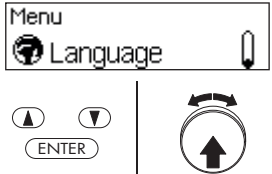
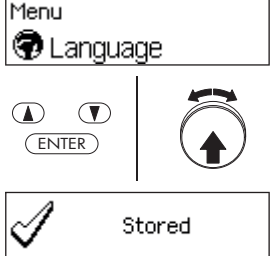
**Setting the dialog language**

|   |   |
|---|---|
| <p>6. Select and confirm the menu option "<b>Language</b>".</p>                     |   |
| <p>7. Select and confirm desired dialog language.</p> <p>The setting is stored.</p> |  |
| <p>The input unit returns automatically to the menu option "Language".</p>          |  |

## 5 Configuring the System

### 5.1 Overview of setting parameters

| Settings   | Paxos advance Standalone Mode (PIN only) | Paxos advance Extended Mode with AS384 Management-Suite Software |                             |
|--|--|--|-----------------------------|
|  |  | (PIN only)   | (ID+PIN)                    |
| <b>Code functions</b>  |  |  |                             |
| Master Code  | ✓  | ✓  | ✓<br>Several Master Codes   |
| Opening Codes a-z and 27-95  | ✓  | ✓  | ✓                           |
| AND Code a and b   | ✓  | ✓  | ✓                           |
| Mutation Code  | ✓  | ✓  | ✓<br>Several Mutation Codes |
| Time Code  | ✓  | ✓  | ✓<br>Multiple Time Codes    |
| Net code   | (✓)                                      | ✓  | ✓<br>Multiple Net Codes     |
| Code profiles  |  |  | ✓                           |
| Code profile groups  |  |  | ✓                           |
| Code type PIN  | ✓  | ✓  |                             |
| Code type ID + PIN   |  |  | ✓                           |
| Time penalties   | ✓  | ✓  | ✓                           |
| <b>Time functions lock 1 (valid for the entire locking system)</b>                   |  |  |                             |
| Date/Time  | ✓  | ✓  | ✓                           |
| Holiday Locking Period   | ✓  | ✓  | ✓                           |
| Yearly Locking Period  | ✓  | ✓  | ✓                           |
| Weekly Locking Period  | ✓  | ✓  | ✓                           |
| Time Lock Override   | ✓  | ✓  | ✓                           |
| Partial Locking  | ✓  | ✓  | ✓                           |
| Opening Delay  | ✓  | ✓  | ✓                           |
| Duress Delay   | ✓  | ✓  | ✓                           |
| Confirmation Window  | ✓  | ✓  | ✓                           |
| Return Time Lock   | ✓  | ✓  | ✓                           |
| Time-Controlled Delay Times  |  | ✓  | ✓                           |
| Summer/Winter Time Changeover  | ✓  | ✓  | ✓                           |
|  |  | Manual or automatic time zone rules                              |                             |
| Synchronization with PC time   |  | ✓  | ✓                           |
| <b>Time functions last lock (values can be set, if partial locking is activated)</b> |  |  |                             |
| Opening Delay  | ✓  | ✓  | ✓                           |
| Duress Delay   | ✓  | ✓  | ✓                           |
| Confirmation Window  | ✓  | ✓  | ✓                           |
| Return Time Lock   | ✓  | ✓  | ✓                           |

| Settings   | Paxos advance Standalone Mode (PIN only) | Paxos advance Extended Mode with AS384 Management-Suite Software |          |
|--|--|--|----------|
|  |  | (PIN only)   | (ID+PIN) |
| <b>Settings lock 1 (valid for the entire locking system)</b> |  |  |          |
| Duration Fast Locking  | ✓  | ✓  | ✓        |
| Duration Time Lock Delay                                     | ✓  | ✓  | ✓        |
| Date/Time Format   | ✓  | ✓  | ✓        |
| Locking Mode   | ✓  | ✓  | ✓        |
| Remote Lock  | ✓  | ✓  | ✓        |
| Parallel Mode  | ✓  | ✓  | ✓        |
| Set Duress Code  | ✓  | ✓  | ✓        |
| Dual Mode  | ✓  | ✓  | ✓        |
| Maximum Open Period  | ✓  | ✓  | ✓        |
| <b>Settings other locks</b>                                  |  |  |          |
| Dual Mode  | ✓  | ✓  | ✓        |
| <b>Settings input unit</b>                                   |  |  |          |
| Dialog language  | ✓  | ✓ *  | ✓ *      |
| Volume   | ✓  | ✓ *  | ✓ *      |
| Lighting   | ✓  | ✓ *  | ✓ *      |
| Contrast   | ✓  | ✓ *  | ✓ *      |
| Battery compartment  | ✓  | ✓ *  | ✓ *      |
| <b>System settings</b>                                       |  |  |          |
| Maximum door opening time                                    | ✓  | ✓  | ✓        |
| Count direction Opening and Duress Delay Time                |  | ✓  | ✓        |
| Count direction Confirmation Window                          |  | ✓  | ✓        |
| Count direction Return Time Delay                            |  | ✓  | ✓        |
| Count direction Penalty Time                                 |  | ✓  | ✓        |
| <b>Duress settings</b>                                       |  |  |          |
| Use duress alarm   | ✓  | ✓  | ✓        |
| Set code position for duress alarm                           |  | ✓  | ✓        |
| <b>Inputs/outputs I/O-Box</b>                                |  |  |          |
| Configure inputs   |  | ✓  | ✓        |
| Configure outputs  |  | ✓  | ✓        |
| <b>Audit</b>   |  |  |          |
| Reading the audit  |  | ✓  | ✓        |
| Export lock information                                      |  | ✓  | ✓        |
| Import audits  |  | ✓  | ✓        |

\* only adjustable on input unit

## 5.2 Code functions

### 5.2.1 General information on the codes

The opening of the locks and all security-relevant configuration settings of the locking system are protected from unauthorized access by codes (formed from the digits 0 to 9). After the initial start and addressing of the locking system, only the Opening Code OCa of each lock (see section 5.2.2 "Standard code types") is activated and set to the **factory code "10203040"**. With the factory code, the locks can be opened and the Opening Code OCa can be changed to an individual code. As soon as the Opening Code has been changed to an individual OCa code, only the Opening Code and the Master Code OCb can be activated with the Opening Code OCa. If the Master Code is enabled, the Opening Code OCa loses the authorization to change other codes. Codes can only be enabled, modified and deleted with the Master Code (MA..), or, if activated, the Mutation Code (MU.) of the respective lock.

To be able to use all functions of the locking system, at least the Opening Codes OCa and OCb and the Master Code must be activated for each lock (see section 5.2.4.1 "Setting the Opening Code OCa., OCb.. and Master Code").



On a existing systems using ID+PIN mode the factory code of newly added locks is "0010203040".



**During operation, it is not accepted to use the factory code as opening code (due to security reason). Therefore setting a code to the factory code will deactivate this code immediately upon saving.**

### 5.2.2 Standard code types

The locking system Paxos advance recognizes the following standard code types with corresponding access rights:

| Code type           | Short title | Description  |
|---------------------|-------------|--|
| <b>Master Code</b>  | <b>MA..</b> | Holders of the Master Code (MA..) have access to all settings of a lock (activate, change and delete code, set and change time functions of the lock, define and change basic settings of the system components, as well as trigger Fast Locking or Time Lock Delay).<br><br>The Master Code is not an Opening Code.   |
| <b>Opening Code</b> | <b>OC..</b> | Holders of the Opening Code (OC..) can open a lock alone or with another person (Dual Mode). Moreover, they can trigger Fast Locking or a Time Lock Delay (if functions are enabled) and modify and delete their own code.<br><br>Note: After the initial start and addressing of the locking system, only the Opening Code OCa of each lock is activated and set to the factory code "10203040" (or "0010203040" with ID+PIN mode). With the factory code, the locks can be opened and the Opening Code OCa can be changed to an individual code. As soon as the Opening Code has been changed to an individual OCa code, only the Opening Code and the Master Code OCb can be activated with the Opening Code OCa. If the Master Code is enabled, the Opening Code OCa loses the authorization to change other codes. Codes can then only be enabled, modified and deleted with the Master Code (MA..), or, if activated, the Mutation Code (MU.) of the respective locks. |
| <b>Net code</b>     | <b>NC..</b> | The holder of the network code can alter network settings as well as change and delete their own code.   |

| Code type            | Short title       | Description  |
|----------------------|-------------------|--|
| <b>Time Code</b>     | <b>TC..</b>       | Holders of the Time Code (TC..) can set or change the time functions of the lock. Moreover, they can trigger Fast Locking or a Time Lock Delay (if functions are enabled) and modify and delete their own code.<br><br>The Time Code is not an Opening Code.   |
| <b>Mutation Code</b> | <b>MU..</b>       | Holders of the Mutation Codes can activate, change and delete codes. Moreover, they can trigger Fast Locking or a Time Lock Delay (if functions are enabled) and modify or delete their own code.<br><br>The Mutation Code is not an Opening Code.   |
| <b>AND Code b</b>    | <b>OCa&amp;..</b> | The standard code types AND-a and AND-b exist only in the operation of the locking system with the code format "PIN only". If the AND Codes are activated, in addition to the Opening Codes OCa.. or OCb..., the corresponding AND Code AND-a or AND-b must be entered to open the corresponding lock. |
| <b>AND Code a</b>    | <b>OCb&amp;..</b> | Holders of the AND Code can change or delete their own codes.<br><br>A lock can not be opened with an And code alone.  |

All enabled codes are stored in the code list of the respective lock and assigned the positions 00 to 99. Depending on whether the locking system is operated with the code format "Pin only" or "ID+PIN", the codes are assigned fixed positions in the code list.

| PIN only) |                          |                  |
|-----------|--------------------------|------------------|
| Position  | Code type                | Code designation |
| 00        | Master Code              | MA ...           |
| 01        | Opening Code a           | OCa ...          |
| 02        | Opening Code b           | OCb ...          |
| 03...94   | Additional Opening Codes | OC ...           |
| 95        | Net Code                 | NC ...           |
| 96        | Time Code                | TC ...           |
| 97        | Mutation Code            | MU ...           |
| 98        | AND Code b               | AND-b ...        |
| 99        | AND Code a               | AND-a ...        |

| ID+PIN   |   |  |
|----------|---|--|
| Position | Code type   | Code designation   |
| 00       | Master Code   | MA ...   |
| 01       | Opening Code a  | OCa ...  |
| 02       | Opening Code b  | OCb ...  |
| 03...99  | Additional Master Codes<br>Mutation Codes<br>Time Codes<br>Opening Codes<br>Net Codes<br>Actuator Codes | MA ...<br>MU ...<br>TC ...<br>OC ...<br>NC ...<br>AC ... |

To be able to use all functions of the locking system, at least the Opening Codes OCa and OCb and the Master Code must be activated for each lock.



**When using the dial knob input unit together with locks with safety class B/C (according to EN 1300) with the code format "PIN only" and activated duress function max. 26 opening codes (01 (OCa) to 26 (OCz)) are available.**



**When using the dial knob input unit together with locks with safety class D (according to EN 1300) or safety class 4 (according to EN 1300 VdS 2396) only code format "ID & PIN" is available.**



## AS384 Management-Suite Software

- In Extended Mode of the locking system with the code format ID+PIN, the AS384 Management-Suite Software allows the following for each lock:
    - Additional master, time, mutation codes and net codes can be assigned.
    - Through user profiles for each code (user) the standard authorizations of the corresponding code type can be extended or restricted, dual mode groups defined, user-defined delays set, code ageing activated and user profiles of a user profile group assigned.
    - Code profile groups with the same access rights can be managed.
  - In Extended Mode of the locking system with the code format "ID+PIN", only the codes "00" (Master Code MA), "01" (Opening Code OCa) and "02" (Opening Code OCb) are pre-set. All other codes ("03"... "99") can be defined individually with the AS384 Management-Suite Software as additional Opening Codes, additional Master Codes, Time Codes, Mutation Codes or Net Codes.
-

### 5.2.3 Code formats

#### Code format in Standalone Mode

In Standalone Mode of Paxos advance (also "PIN only mode") a code consists of a **PIN of 8 digits** (numbers from 0 to 9).

#### Code formats in Extended Mode

The Extended Mode of the locking system is only possible in conjunction with the AS384 Management-Suite Software. In Extended Mode, the locking system can be operated with the code formats "**PIN only**" or "**ID+PIN**". Each code is unique when operating with "**ID+PIN**" because the ID is generated from the two-digit position number of the code in the code list.



#### CAUTION

##### Notes on code setting

The codes (PIN) must necessarily consist of randomly formed numbers. Do not use for the codes:

- simple series of numbers such as 11223344
- combinations of dates of birth or other personal information
- codes from the demo code list (see section 9.2 "Factory code / Demonstration code list")

### 5.2.4 Setting new codes

#### 5.2.4.1 Setting the Opening Code OCa., OCb.. and Master Code

To use all the functions of the locking system, for each door and inner compartment lock at least the Opening Codes OCa.. and OCb.. and the Master Code MA must have been activated by assigning an individual code. The procedure described below is based on a system that has been addressed, but to which individual codes have not been assigned yet.



**Authorization: Opening Code OCa with factory code "10203040"**

**Requirement: System status "Unlocked"** (door locks and door bolt open)

To activate with individual codes the Opening Codes OCa.. and OCb.. and the Master Code MA., proceed as follows:



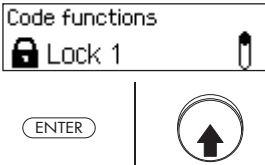
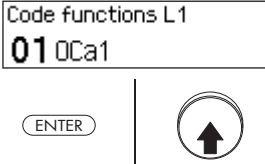
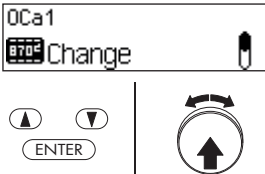
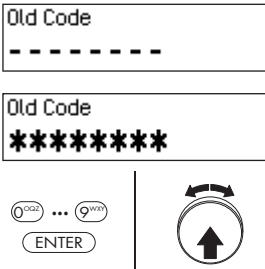
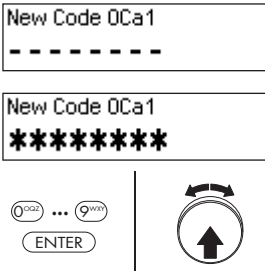
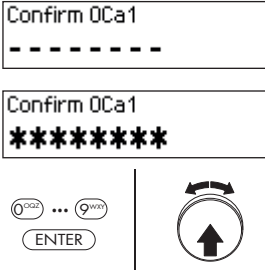

|   |  |
|---|--|
| <p>1. Wake up display (if necessary) and access menu.</p>             |  |
| <p>2. Select and confirm the menu option "<b>Code functions</b>".</p> |  |

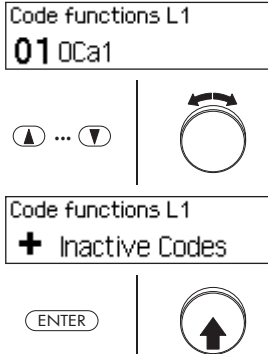
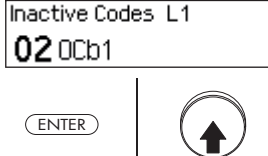
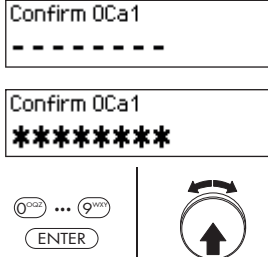
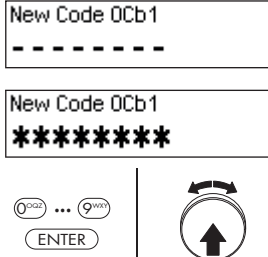
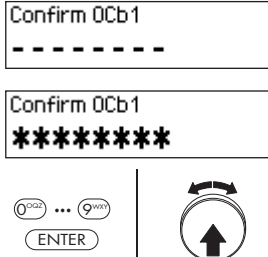
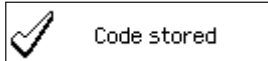

|   |  |
|---|--|
| <p>3. Select and confirm the desired lock (e.g. lock 1).</p>                            |  <p>Code functions<br/>Lock 1</p> <p>ENTER</p> <p>Up arrow</p>                                |
| <p><b>Defining the Opening Code OCa</b></p>   |  |
| <p>4. Confirm code function Opening Code OCa.</p>                                       |  <p>Code functions L1<br/>01 OCa1</p> <p>ENTER</p> <p>Up arrow</p>                            |
| <p>5. Select and confirm menu option "Change".</p>                                      |  <p>OCa1<br/>Change</p> <p>ENTER</p> <p>Up arrow</p>  |
| <p>6. Enter and confirm factory code "10203040" (or "0010203040" with ID+PIN mode).</p> |  <p>Old Code<br/>-----</p> <p>Old Code<br/>*****</p> <p>ENTER</p> <p>Up arrow</p>            |
| <p>7. Enter and confirm new individual Opening Code OCa for the selected lock.</p>      |  <p>New Code OCa1<br/>-----</p> <p>New Code OCa1<br/>*****</p> <p>ENTER</p> <p>Up arrow</p> |
| <p>8. Enter and confirm again the specified Opening Code OCa for the selected lock.</p> |  <p>Confirm OCa1<br/>-----</p> <p>Confirm OCa1<br/>*****</p> <p>ENTER</p> <p>Up arrow</p>   |
| <p>The new Opening Code OCa is stored.</p>  |  <p>Code stored</p>   |

**Defining the Opening Code OCb**

|   |  |
|---|--|
| <p>9. Select and confirm menu option <b>"Inactive Codes"</b>.<br/>                 Note: All not yet activated codes are on the sub-menu "Inactive codes" and may be selected for activation.</p> |  <p>Code functions L1<br/>01 OCa1</p> <p>Code functions L1<br/>+ Inactive Codes</p> |
| <p>10. Confirm code function Opening Code OCb.</p>  |  <p>Inactive Codes L1<br/>02 OCb1</p>   |
| <p>11. Enter and confirm the individual Opening Code OCa entered in steps 7 and 8.</p>  |  <p>Confirm OCa1<br/>-----</p> <p>Confirm OCa1<br/>*****</p>                       |
| <p>12. Enter and confirm individual Opening Code OCa for the selected lock.</p>   |  <p>New Code OCb1<br/>-----</p> <p>New Code OCb1<br/>*****</p>                    |
| <p>13. Enter and confirm again the defined Opening Code OCa for the selected lock.</p>  |  <p>Confirm OCb1<br/>-----</p> <p>Confirm OCb1<br/>*****</p>                      |
| <p>The new Opening Code OCb is stored.</p>  |  <p>Code stored</p>   |

|  |  |
|--|--|
| <p>14. Confirm code function Master Code.</p>  | <div style="border: 1px solid black; padding: 5px;"> <p>Inactive Codes L1<br/><b>00</b> MA1</p> <div style="display: flex; justify-content: space-between; align-items: center;"> <span>ENTER</span>  </div> </div>   |
| <p>15. Enter and confirm the individual Opening Code OCa entered in steps 7 and 8.</p>   | <div style="border: 1px solid black; padding: 5px;"> <p>Confirm OCa1<br/>-----</p> <div style="border: 1px solid black; padding: 5px;"> <p>Confirm OCa1<br/><b>*****</b></p> </div> <div style="display: flex; justify-content: space-between; align-items: center;"> <span>0000 ... 9999<br/>ENTER</span>  </div> </div> |
| <p>16. Enter and confirm new individual Master Code for the selected lock.</p>   | <div style="border: 1px solid black; padding: 5px;"> <p>New Code MA1<br/>-----</p> <div style="border: 1px solid black; padding: 5px;"> <p>New Code MA1<br/><b>*****</b></p> </div> <div style="display: flex; justify-content: space-between; align-items: center;"> <span>0000 ... 9999<br/>ENTER</span>  </div> </div> |
| <p>17. Enter and confirm again the defined Master Code for the selected lock.</p>  | <div style="border: 1px solid black; padding: 5px;"> <p>Confirm MA1<br/>-----</p> <div style="border: 1px solid black; padding: 5px;"> <p>Confirm MA1<br/><b>*****</b></p> </div> <div style="display: flex; justify-content: space-between; align-items: center;"> <span>0000 ... 9999<br/>ENTER</span>  </div> </div> |
| <p>The new Master Code is stored. Once the Master Code is stored, new codes for the corresponding lock can only be created by the holder of the Master Code.</p> | <div style="border: 1px solid black; padding: 5px;"> <div style="display: flex; align-items: center;">  <span>Code stored</span> </div> <div style="border: 1px solid black; padding: 5px; margin-top: 5px;"> <p>Inactive Codes L1<br/><b>03</b> OCa1</p> </div> </div>                     |
| <p>18. Repeat steps 3 to 17 for all door and safe locks.</p>   |  |

### 5.2.4.2 Defining new codes (e.g. additional Opening Codes, Time Codes, Mutation Codes, Net codes, etc.)



New codes can be set only by holders of the Master Code or, if already enabled, holders of the Mutation Code.

All inactive codes are listed in the submenu "Inactive codes" of the menu "Code functions" of the respective lock.



#### AS384 Management-Suite Software

In the extended mode of the locking system with code format ID+PIN, other codes besides the Master Code and Mutation Codes can also be assigned the right to define new codes, by using the AS384 Management-Suite Software.



**During operation, it is not accepted to use the factory code as opening code (due to security reason). Therefore setting a code to the factory code will deactivate this code immediately upon saving.**

**Authorization: Master Code, Mutation Code (can only define Opening Codes)**

**Requirement: System status "Unlocked"** (door locks and door bolt open)

To activate other codes, proceed as follows:

|  |  |
|--|--|
| <p>1. Wake up display (if necessary) and access menu.</p>      |  |
| <p>2. Select and confirm the menu option "Code functions".</p> |  |
| <p>3. Select and confirm the desired lock (e.g. lock 1).</p>   |  |

#### Defining new codes (e.g. Time Code)

|  |  |
|--|--|
| <p>4. Select and confirm menu option "Inactive Codes".</p> |  |
|--|--|

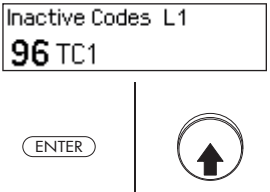
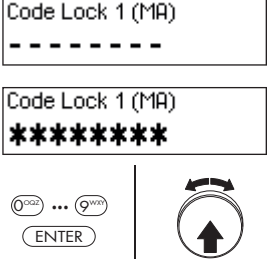
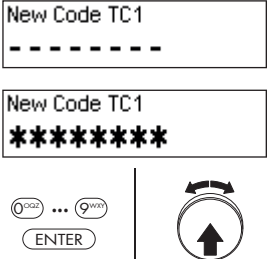
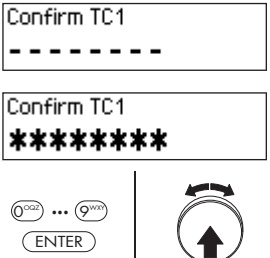
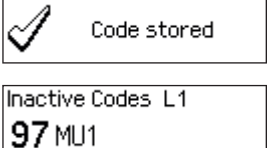
|  |   |
|--|---|
| <p>5. Select and confirm desired code function (e.g. code function Time Code).</p> <p>Note: The Time Code "TC" is a standard code type and is located at position 96 of the code list. Other positions of standard codes are 95 (Net code "NC"), 97 (Mutation Code "MU"), 98 (AND Code b "OCb&amp;") and 99 (AND Code a "OCa&amp;").</p> |    |
| <p>6. Select and confirm Master Code, or if a new Opening Code should be defined, enter the Mutation Code for the selected lock.</p> <p>Note: If a new Opening Code is to be defined, the Mutation Code can also be entered (if activated).</p>  |    |
| <p>7. Enter and confirm a new individual code (such as Time Code "TC1") for the selected lock.</p>   |    |
| <p>8. Enter and confirm again specified code (e.g. Time Code "TC1") for the selected lock.</p>   |  |
| <p>The new code is stored. From now on, the newly activated code appears in the list of active codes.</p>  |  |
| <p>9. Repeat steps 3 through 8 for the codes of all locks that you want to redefine.</p>   |   |

### 5.2.5 Deleting or changing existing codes



Changing codes: Existing codes can only be changed or deleted by the code holder, the Master Code or the Mutation Code.



#### AS384 Management-Suite Software

In Extended Mode of the locking system with code format ID+PIN, other codes, in addition to the Master Code and Mutation Codes, can also be assigned the right to change and delete foreign codes, by using the AS384 Management-Suite Software.

**Authorization: Code holder (only code change), Master Code, Mutation Code**

**Requirement: System status "Unlocked"** (door locks and door bolt open)

To modify or delete existing codes, proceed as follows:





|  |  |
|--|--|
| <p>1. Wake up display (if necessary) and access menu.</p>  |  |
| <p>2. Select and confirm the menu option "Code functions".</p>                                       |  |
| <p>3. Select and confirm the desired lock (e.g. lock 1).</p>   |  |
| <p>4. Select desired code (e.g. "OCc1") that you want to change or delete and confirm selection.</p> |  |

**To change a code, proceed to step 5.**

**To delete a code, proceed to step 10.**

#### Changing codes

|  |  |
|--|--|
| <p>5. Select and confirm menu option "Change".</p> |  |
|--|--|

|  |  |
|--|--|
| <p>6. Enter and confirm old Code (or Master Code or Mutation Code) for the selected lock.</p>  | <div style="border: 1px solid black; padding: 2px; margin-bottom: 2px;">Old Code<br/>-----</div> <div style="border: 1px solid black; padding: 2px; margin-bottom: 2px;">Old Code<br/>*****</div> <div style="display: flex; justify-content: space-between; align-items: center;"> <div style="text-align: center;"> <small>0 000 ... 9 999</small><br/>             ENTER         </div> <div style="text-align: center;">  </div> </div>           |
| <p>7. Enter and confirm new individual code.<br/>Note: If a code is changed to "10203040" (factory code), it is automatically deleted.</p> | <div style="border: 1px solid black; padding: 2px; margin-bottom: 2px;">New Code OCc1<br/>-----</div> <div style="border: 1px solid black; padding: 2px; margin-bottom: 2px;">New Code OCc1<br/>*****</div> <div style="display: flex; justify-content: space-between; align-items: center;"> <div style="text-align: center;"> <small>0 000 ... 9 999</small><br/>             ENTER         </div> <div style="text-align: center;">  </div> </div> |
| <p>8. Enter and confirm again new code.</p>  | <div style="border: 1px solid black; padding: 2px; margin-bottom: 2px;">Confirm OCc1<br/>-----</div> <div style="border: 1px solid black; padding: 2px; margin-bottom: 2px;">Confirm OCc1<br/>*****</div> <div style="display: flex; justify-content: space-between; align-items: center;"> <div style="text-align: center;"> <small>0 000 ... 9 999</small><br/>             ENTER         </div> <div style="text-align: center;">  </div> </div>  |
| <p>The new code is stored.</p>   | <div style="border: 1px solid black; padding: 2px; margin-bottom: 2px;">  Code stored         </div> <div style="border: 1px solid black; padding: 2px;">Code functions L1<br/><b>03</b> OCc1</div>   |
| <p>9. Repeat steps 5 through 8 for all codes of the selected lock that you want to change.</p>   |  |

**Deleting codes**

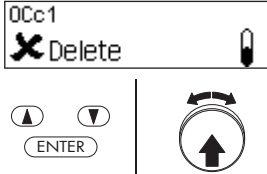
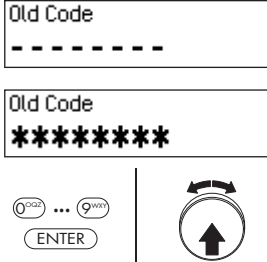
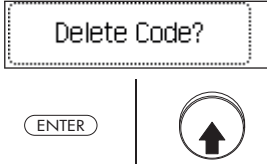
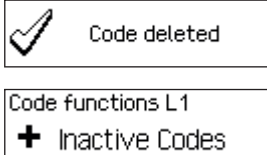
|   |  |
|---|--|
| <p>10. Select and confirm menu option <b>"Delete"</b>.</p>  |   |
| <p>11. Enter and confirm old Code (or Master Code or Mutation Code) for the selected lock.</p>    |   |
| <p>12. Confirm deletion of code.</p>  |   |
| <p>The selected code is deleted.</p>  |  |
| <p>13. Repeat steps 10 through 12 for all codes of the selected lock that you want to delete.</p> |  |



## 5.3 Time functions

### 5.3.1 General information on the time functions

In the menu time functions, define the time-related settings for the locks, like date and time, locking times, delay times, etc. The following table provides an overview of which functions can be set where and for which locks they are valid.

| Time function          | Door lock 1 | Last door lock | Inner compartment locks |
|------------------------|-------------|----------------|-------------------------|
| Required code          | MA1 or TC1  | MA... or TC... | MA... or TC...          |
| Date/Time              | ✓ *         | ---            | ---                     |
| Summer/Winter time     | ✓ *         | ---            | ---                     |
| Holiday Locking Period | ✓ *         | ---            | ---                     |
| Yearly Locking Period  | ✓ *         | ---            | ---                     |
| Weekly Locking Period  | ✓ *         | ---            | ---                     |
| Time Lock Override     | ✓ *         | ---            | ---                     |
| Partial Locking        | ✓ *         | ---            | ---                     |
| Opening Delay          | ✓ *         | ✓ **           | ✓ ***                   |
| Duress Delay           | ✓ *         | ✓ **           | ✓ ***                   |
| Confirmation Window    | ✓ *         | ✓ **           | ✓ ***                   |
| Return Lock            | ✓ *         | ✓ **           | ✓ ***                   |

\* Settings are valid for the entire locking system

\*\* May be changed when Partial Locking is enabled

\*\*\* Can be changed for each inner compartment lock



#### AS384 Management-Suite Software

In Extended Mode of the locking system, additional time functions can be set:

- User and time controlled opening and Duress Delays
- Count direction of the delay times for display in the input unit
- Automatic synchronization with PC clock
- Automatic summer/winter time changeover using time zone rules or fixed dates and times for the beginning and end of summer time.

### 5.3.2 Setting the current date and time

**Authorization:** Master Code "MA1", Time Code "TC1"

**Requirement:** System status "Unlocked" (door locks and door bolt open)

To set the current date and time, proceed as follows:



- The corresponding days of the week and leap years are automatically determined using the built-in calendar function (calendar section: Jan-1-2010 to Dec-31-2099). Therefore, it is important that the current date and time are set correctly.
- The current date and time have validity for the entire system.
- For setting the date and time formats please observe the notes in section 5.4.2.4 „Setting the date and time format“).





#### AS384 Management-Suite Software

In Extended Mode, the following can be executed with AS384 Management-Suite Software:

- The date and time can be automatically synchronized with the computer clock.
- The summer/winter time changeover can be controlled using the time zone rules or a unique time stamp (beginning and end).

To set the current date and time, proceed as follows:

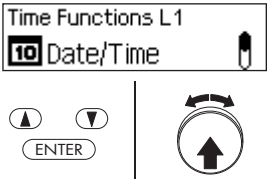
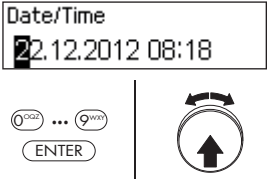
|  |  |
|--|--|
| 1. Wake up display (if necessary) and access menu.         |  |
| 2. Select and confirm the menu option "Time Functions".    |  |
| 3. Select and confirm menu option "Time Functions Lock 1". |  |
| 4. Enter and confirm Master Code (or Time Code) of lock 1. |  |

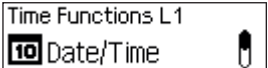
|  |   |
|--|---|
| <p>5. Select and confirm the menu option <b>“Time Functions L1 Date/Time”</b>.</p>   |  |
| <p>6. Set and confirm the current date and current time.<br/>         Note: The input format is dependent on the selected date/time format (see section 5.4.2.4 "Setting the date and time format").</p> |  |
| <p>The entered date is stored.</p>   |  |
| <p>The input unit returns to the menu option “Timer functions Date/Time”.</p>  |  |

### 5.3.3 Setting, changing, deleting a Holiday Locking Period

The **“Holiday Locking Period”** function allows you to define up to 24 locking periods for non-recurring **vacation and holidays** (e.g. for company holidays, year-specific public holidays).



- Setting range for holiday locking time **1 Minute to 34 days 23 hours and 45 minutes**.
- The minimum time interval between two Holiday Locking Periods must be at least 1 day. Exception 28.02. – 01.03. due to the leap year.
- Holiday Locking Periods are stored in the Holiday Locking Period list in chronological order.
- Any weekly or Yearly Locking Periods have no effect while the Holiday Locking Period is active – the Holiday Locking Periods vacation time overrides the weekly and Yearly Locking Periods.
- No Holiday Locking Periods can be created for the past.
- Holiday Locking Periods can only be changed or deleted as long as they have not started.
- Once a Holiday Locking Period has elapsed, is it deleted and the Holiday Locking Period list is chronologically updated.

**Authorization: Master Code “MA1”, Time Code “TC1”**





**Requirement: System status “Unlocked”** (door locks and door bolt open)

To set, modify or delete existing Holiday Locking Periods, proceed as follows:

|  |  |
|--|--|
| <p>1. Wake up display (if necessary) and access menu.</p>                |  |
| <p>2. Select and confirm the menu option <b>“Time Functions”</b>.</p>    |  |
| <p>3. Select and confirm menu option <b>“Time Functions Lock 1”</b>.</p> |  |
| <p>4. Enter and confirm Master Code (or Time Code) of lock 1.</p>        |  |

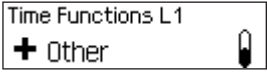
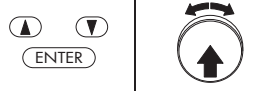
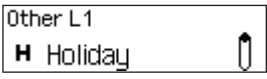
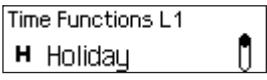
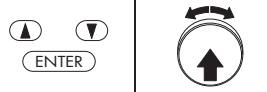
To **set a new Holiday Locking Period**, continue with **step 5**.  
 To **change an existing Holiday Locking Period**, continue with **step 10**.  
 To **delete an existing Holiday Locking Period**, continue with **step 15**.

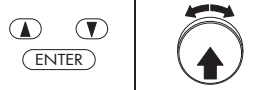
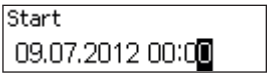
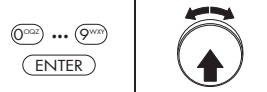
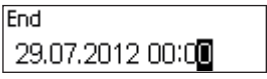
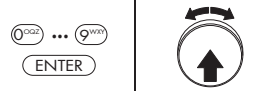
**Setting a new Holiday Locking Period**

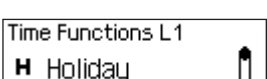
|  |   |
|--|---|
| <p>5. If no Holiday Locking Periods have been configured yet, select and confirm the menu option <b>“Time Functions L1 Other”</b>.</p>   |     |
| <p>6. Select and confirm menu option <b>“Other L1 Holiday”</b> (Holiday Locking Periods not configured yet) or <b>“Time Functions L1 Holiday”</b> (Holiday Locking Periods already configured).</p>  |    |
| <p>7. Select and confirm next unused Holiday Locking Period (e.g. Holiday Locking Period 02).</p>  |    |
| <p>8. Set and confirm date and time for the beginning of the selected Holiday Locking Period.<br/>                 Note: The input format is dependent on the selected date/time format (see section 5.4.2.4 "Setting the date and time format").</p>    |     |
| <p>9. Set and confirm date and time for the end of the selected Holiday Locking Period.</p>  |     |
| <p>The Holiday Locking Period is stored.</p> <p>The input unit returns to the menu option <b>“Time Functions L1 Holiday”</b>. You can now configure additional Holiday Locking Periods (repeat steps 6 to 9) or return to the standard mode display.</p> |     |

**Changing a Holiday Locking Period**

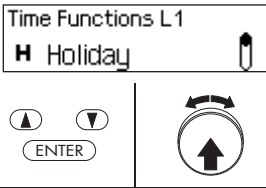
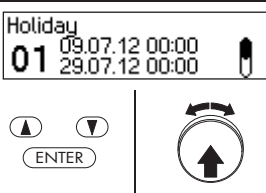
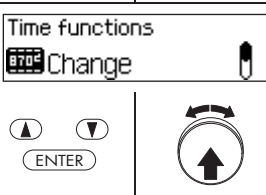
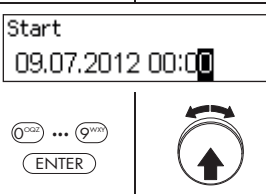
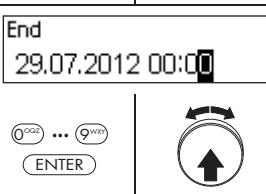
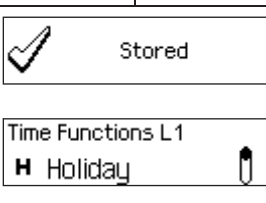
|   |   |
|---|---|
| <p>10. Select and confirm menu option <b>"Time Functions L1 Holiday"</b>.</p>   |    |
| <p>11. Select and confirm desired Holiday Locking Period.</p>   |    |
| <p>12. Select and confirm menu option <b>"Change"</b>.</p>  |    |
| <p>13. Set and confirm new date and/or time for the start of the selected Holiday Locking Period.<br/>Note: The input format is dependent on the selected date/time format (see section 5.4.2.4 "Setting the date and time format").</p>                    |   |
| <p>14. Set and confirm new date and/or new time for the end of the selected Holiday Locking Period.</p>   |  |
| <p>The changed Holiday Locking Period is stored.</p> <p>The input unit returns to the menu option "Time Functions L1 Holiday". You can now configure additional Holiday Locking Periods (repeat steps 10 to 14) or return to the standard mode display.</p> |  |

**Deleting a Holiday Locking Period**

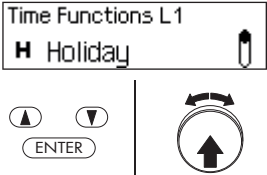
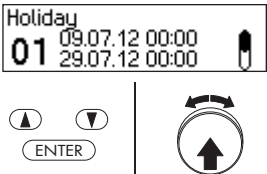
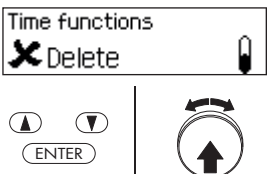
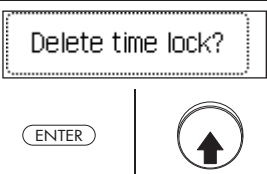
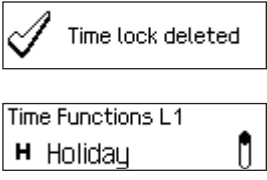
|   |   |
|---|---|
| <p>15. Select and confirm menu option “<b>Time Functions L1 Holiday</b>”.</p>   |    |
| <p>16. Select and confirm the Holiday Locking Period you want to delete.</p>  |    |
| <p>17. Select and confirm menu option “<b>Delete</b>”.</p>  |    |
| <p>18. Confirm deletion.</p>  |   |
| <p>The Holiday Locking Period is deleted.</p> <p>The input unit returns to the menu option “Time Functions L1 Holiday”. You can now delete additional Holiday Locking Periods (repeat steps 15 to 18) or return to the standard mode display.</p> |  |

### 5.3.4 Setting, changing, deleting a Yearly Locking Period

The function **Yearly Locking Period** allows the definition of **locking periods for holidays recurring each year at the same date and time**.



- **A maximum of 28 Yearly Locking periods** can be set.
- Setting range year locking period: **1 Minute to 34 days 23 hours and 45 minutes**.
- Yearly Locking Periods do not expire. If a Yearly Locking Period is no longer needed (e.g. an eliminated holiday), it must be deleted.
- If the final date of a Yearly Locking Period is the last day of February, we recommend setting it to the 29th of February. Thus, leap years will automatically be included.
- Yearly Locking Periods can only be changed or deleted as long as they have not started.

**Authorization: Master Code "MA1", Time Code "TC1"**

**Requirement: System status "Unlocked"** (door locks and door bolt open)

To set, modify or delete existing Yearly Locking Periods, proceed as follows:

|  |  |
|--|--|
| 1. Wake up display (if necessary) and access menu.         |  |
| 2. Select and confirm the menu option "Time Functions".    |  |
| 3. Select and confirm time function lock 1.                |  |
| 4. Enter and confirm Master Code (or Time Code) of lock 1. |  |



To **set a new Yearly Locking Period**, continue with **step 5**.

To **change an existing Yearly Locking Period**, continue with **step 10**.



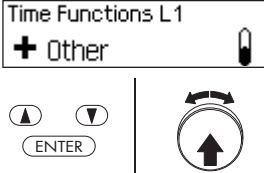
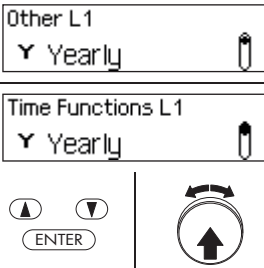
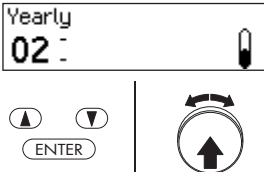

To **delete an existing Yearly Locking Period**, continue with **step 15**.

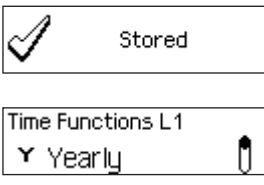



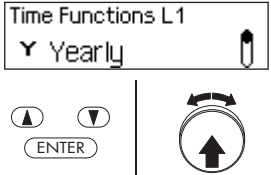

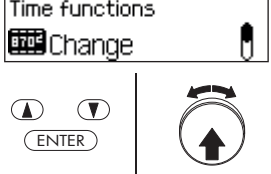
**Setting a new Yearly Locking Period**

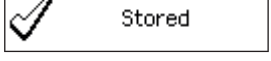
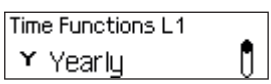
|  |   |
|--|---|
| <p>5. If no Yearly Locking Periods have been configured yet, select and confirm the menu option "Time Functions L1 Other".</p>   |    |
| <p>6. Select and confirm menu option "Other L1 Yearly" or "Time Functions L1 Yearly".</p>  |    |
| <p>7. Select and confirm next unassigned Yearly Locking Period (e.g. Yearly Locking Period 02).</p>  |    |
| <p>8. Set the date (day and month) and time for the start of the selected Yearly Locking Period and confirm.</p>   |   |
| <p>9. Set the date (day and month) and time for the end of the selected Yearly Locking Period and confirm.</p>   |  |
| <p>The Yearly Locking Period is stored.</p> <p>The input unit returns to the menu option "Time Functions L1 Yearly". You can now configure additional Yearly Locking Periods (repeat steps 6 to 9) or return to the standard mode display.</p> |  |

**Changing a Yearly Locking Period**

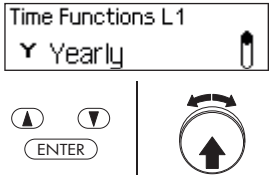
|  |  |
|--|--|
| <p>10. Select and confirm menu option <b>“Time Functions L1 Yearly”</b>.</p>   |   |
| <p>11. Select and confirm desired Yearly Locking Period.</p>   |   |
| <p>12. Select and confirm menu option <b>“Change”</b>.</p>   |   |
| <p>13. Set and confirm new date and/or new time for the start of the selected Yearly Locking Period.</p>   |    |
| <p>14. Set and confirm new date and/or new time for the end of the selected Yearly Locking Period.</p>   |   |
| <p>The changed Holiday Locking Period is stored.</p> <p>The input unit returns to the menu option <b>“Time Functions L1 Yearly”</b>. You can now configure additional Yearly Locking Periods (repeat steps 10 to 14) or return to the standard mode display.</p> | <br> |

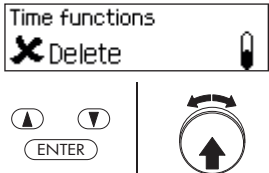
**Deleting a Yearly locking Period**

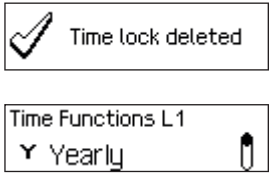
|  |   |
|--|---|
| <p>15. Select and confirm menu option “<b>Time Functions L1 Yearly</b>”.</p>   |    |
| <p>16. Select and confirm the Yearly Locking Period you want to delete.</p>  |    |
| <p>17. Select and confirm menu option “<b>Delete</b>”.</p>   |    |
| <p>18. Confirm deletion.</p>   |   |
| <p>The changed Yearly Locking Period is stored.</p> <p>The input unit returns to the menu option “Time Functions L1 Yearly”. You can now configure additional Yearly Locking Periods (repeat steps 15 to 18) or return to the standard mode display.</p> |  |

### 5.3.5 Setting, changing and deleting a Weekly Locking Period

The **Weekly Locking Periods** allow the definition of **locking periods for weekly recurring events** (e.g. locking outside of business hours).



- **A maximum of 28 Weekly Locking periods** can be set.
- Setting range of Weekly Locking Period: **1 Minute to 6 days 23 hours and 45 minutes**.
- Weekly Locking Periods do not expire. If a Weekly Locking Period is no longer needed, it must be deleted.
- The maximum duration of a Weekly Locking Period is limited to 6 days, 23 hours and 45 minutes.
- The minimum duration for a Weekly Locking Period is limited to 1 minute.
- The minimum time interval between two Weekly Locking Periods is calculated automatically by the system, based on:  
 Opening Delay time (or the Duress Delay if greater) + confirmation time + 1 minute  
 Without Opening Delay time the minimum time interval is 15 minutes.  
 If the minimum time interval of the input is lower, an error message appears.
- Weekly Locking Periods are stored in the Weekly Locking Period list in chronological order.
- Weekly Locking Periods have no effect during an active Holiday Locking Period – Holiday Locking Periods override Weekly Locking Periods.
- Weekly Locking Periods can only be changed or deleted as long as they have not started.

**Authorization: Master Code “MA1”, Time Code “TC1”**

**Requirement: System status “Unlocked”** (door locks and door bolt open)



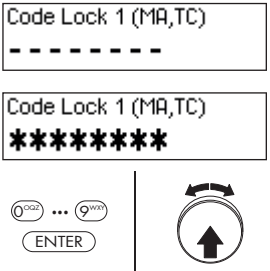

To set, change or delete existing Weekly Locking Periods, proceed as follows:

|   |  |
|---|--|
| 1. Wake up display (if necessary) and access menu.                  |  |
| 2. Select and confirm the menu option “ <b>Time Functions</b> ”.    |  |
| 3. Select and confirm menu option “ <b>Time Functions Lock 1</b> ”. |  |

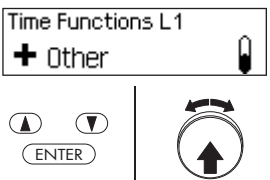
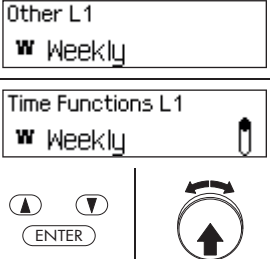
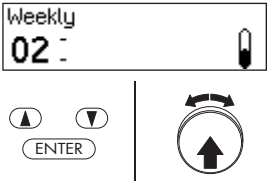

|   |   |
|---|---|
| <p>4. Enter and confirm Master Code (or Time Code) of lock 1.</p> |  |
|---|---|

To set a new Weekly Locking Period, continue with **step 5**.  
 To change an existing Weekly Locking Period, continue with **step 10**.  
 To delete an existing Weekly Locking Period, continue with **step 15**.

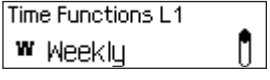
**Setting a new Weekly Locking Period**

|  |   |
|--|---|
| <p>5. If no Weekly Locking Periods have been configured yet, select and confirm the menu option "Time Functions L1 Other".</p>   |    |
| <p>6. Select and confirm menu option "Other L1 Weekly" or "Time Functions L1 Weekly".</p>  |   |
| <p>7. Select and confirm next unassigned Weekly Locking Period (e.g. Weekly Locking Period 02).</p>  |    |
| <p>8. Set and confirm date and time for the start of the selected Weekly Locking Period.</p>   |    |
| <p>9. Set and confirm date and time for the end of the selected Weekly Locking Period.</p>   |    |
| <p>The Weekly Locking Period is stored.</p> <p>The input unit returns to the menu option "Time Functions L1 Weekly". You can now configure additional Weekly Locking Periods (repeat steps 6 to 9) or return to the standard mode display.</p> |   |

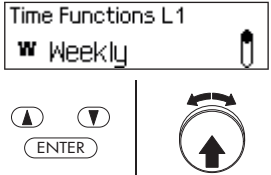
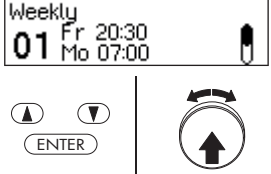
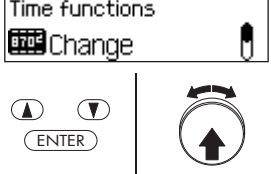
**Changing a Weekly Locking Period**

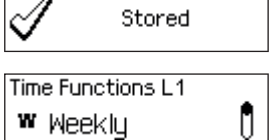
|  |   |
|--|---|
| <p>10. Select and confirm menu option <b>“Time Functions L1 Weekly”</b>.</p>   |    |
| <p>11. Select and confirm desired Weekly Locking Period.</p>   |    |
| <p>12. Select and confirm menu option <b>“Change”</b>.</p>   |    |
| <p>13. Set and confirm new date and/or new time for the start of the selected Weekly Locking Period.</p>   |   |
| <p>14. Set and confirm new date and/or new time for the end of the selected Weekly Locking Period.</p>   |  |
| <p>The changed Holiday Locking Period is stored.</p> <p>The input unit returns to the menu option <b>“Time Functions L1 Weekly”</b>. You can now configure additional Weekly Locking Periods (repeat steps 10 to 14) or return to the standard mode display.</p> |  |

**Deleting Weekly Locking Periods**

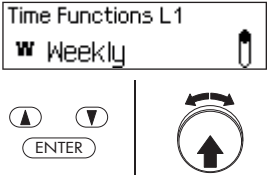
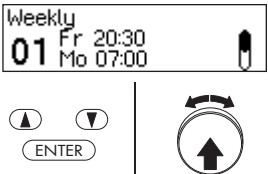
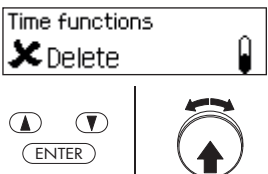
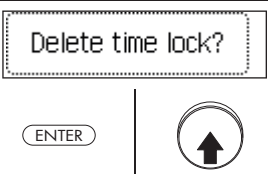
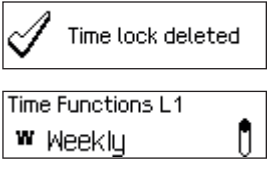
|  |   |
|--|---|
| <p>15. Select and confirm menu option “<b>Time Functions L1 Weekly</b>”.</p>   |    |
| <p>16. Select and confirm the Weekly Locking Period you want to delete.</p>  |    |
| <p>17. Select and confirm menu option “<b>Delete</b>”.</p>   |    |
| <p>18. Confirm deletion.</p>   |   |
| <p>The Weekly Locking Period is deleted.</p> <p>The input unit returns to the menu option “Time Functions L1 Weekly”. You can now delete additional Weekly Locking Periods (repeat steps 15 to 18) or return to the standard mode display.</p> |  |

### 5.3.6 Setting, changing and deleting a Time Lock Override

The function **Time Lock Override** allows the definition of **time windows during which locking periods are interrupted and the locks can be opened.**



- **A maximum of 8 Time Lock Overrides** can be set.
- Setting range of a Time Lock Override: **1 to 144 hours**.
- Defined Time Lock Overrides are stored in the list in chronological order.
- No Time Lock Overrides can be created for the past.
- Once a Time Lock Override has elapsed, it is deleted and the list with the defined Time Lock Overrides is chronologically updated.
- Once a locking period has started no Time Lock Overrides can be set, changed or deleted.

**Authorization: Master Code "MA1", Time Code "TC1"**

**Requirement: System status "Unlocked"** (door locks and door bolt open)

To set new Time Lock Overrides, proceed as follows:

|  |  |
|--|--|
| <p>1. Wake up display (if necessary) and access menu.</p>                |  |
| <p>2. Select and confirm the menu option "<b>Time Functions</b>".</p>    |  |
| <p>3. Select and confirm menu option "<b>Time Functions Lock 1</b>".</p> |  |
| <p>4. Enter and confirm Master Code (or Time Code) of lock 1.</p>        |  |



To **set a new Time Lock Override**, continue with **step 5**.

To **change an existing Time Lock Override**, continue with **step 10**.



To **delete an existing Time Lock Override**, continue with **step 15**.

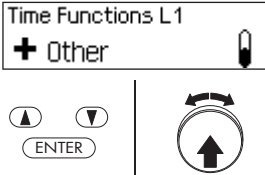
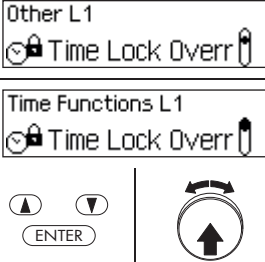
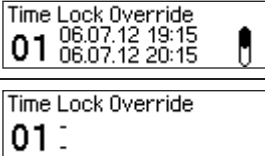
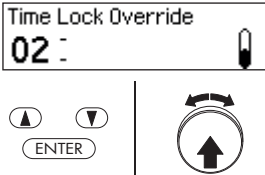
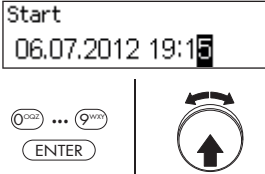

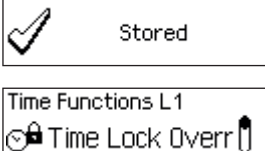

**Setting a new Time Lock Override**

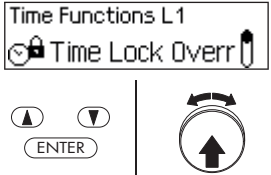
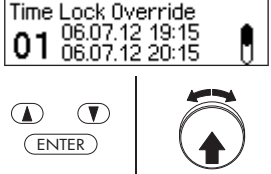
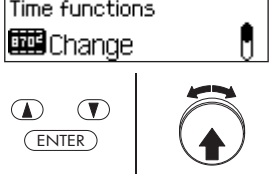
|  |   |
|--|---|
| <p>5. If no Time Lock Overrides have been configured yet, select and confirm the menu option "Time Functions L1 Other".</p>  |    |
| <p>6. Select and confirm menu option "Other L1 Time Lock Overr." or "Time Functions L1 Time Lock Overr.".</p>  |    |
| <p>If Time Lock Overrides have already been configured, the display with the data "Time Lock Interrupt. 01". Otherwise, the display of the "Time Lock Interrupt. 01" appears without data.</p>   |    |
| <p>7. Select and confirm the next Time Lock Override (e.g. "Time Lock Interrupt. 02").</p>   |   |
| <p>8. Set and confirm date and time for the start of the selected Time Lock Override.</p>  |  |
| <p>9. Set and confirm date and time for the end of the selected Time Lock Override.</p>  |  |
| <p>The Time Lock Override is stored.</p> <p>The input unit returns to the menu option "Time Functions L1 Time Lock Overr.". You can now configure additional Time Lock Overrides (repeat steps 5 to 9) or return to the standard mode display.</p> |  |

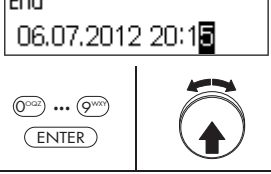
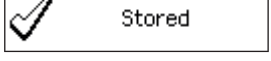
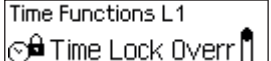
**Changing Time Lock Overrides**

|  |  |
|--|--|
| <p>10. Select and confirm menu option <b>“Time Functions L1 Time Lock Overr.”</b>.</p>   |   |
| <p>11. Select and confirm the Time Lock Override you want to change.</p>   |   |
| <p>12. Select and confirm menu option <b>“Change”</b>.</p>   |   |
| <p>13. Set and confirm new date and/or new time for the start of the selected Time Lock Override.</p>  |    |
| <p>14. Set and confirm new date and/or new time for the end of the selected Time Lock Override.</p>  |   |
| <p>The changed Time Lock Override is stored.</p> <p>The input unit returns to the menu option “Time Functions L1 Time Lock Overr.”. You can now configure additional Time Lock Overrides (repeat steps 10 to 14) or return to the standard mode display.</p> | <br> |

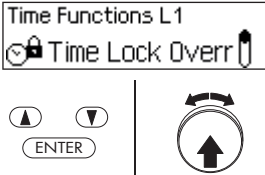
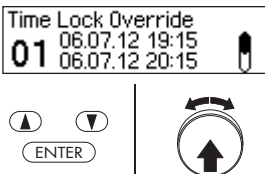
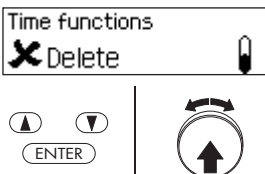
**Deleting Time Lock Overrides**

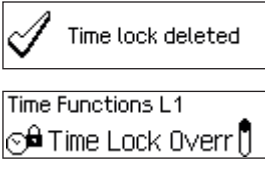
|   |   |
|---|---|
| <p>15. Select and confirm menu option <b>“Time Functions L1 Time Lock Overr.”</b></p>   |    |
| <p>16. Select and confirm the Time Lock Override you wish to change.</p>  |    |
| <p>17. Select and confirm menu option <b>“Delete”</b>.</p>  |    |
| <p>18. Confirm deletion.</p>  |   |
| <p>The Time Lock Override is deleted.</p> <p>The input unit returns to the menu option <b>“Time Functions L1 Time Lock Overr.”</b>. You can now delete additional Time Lock Overrides (repeat steps 15 to 18) or return to the standard mode display.</p> |  |

### 5.3.7 Setting, changing and deleting Partial Locking

The function **Partial Locking** allows the definition of **time windows during which the door locks may be partly locked**. If a Partial Locking is active, only the last lock (with 2 locks: door lock 2, with 3 locks: door lock 3) when the container door is locked.



- **A maximum of 28 Partial Locking periods** can be set.
- Setting range for Partial Locking: **1 minute to 6 days 23 hours and 45 minutes**.
- Defined Time Lock Overrides are stored in the list in chronological order.
- Locking period interruptions do not expire.

**Authorization: Master Code "MA1", Time Code "TC1"**

**Requirement: System status "Unlocked"** (door locks and door bolt open)

To set, change or delete existing Partial Locking Period, proceed as follows:





|  |  |
|--|--|
| <p>1. Wake up display (if necessary) and access menu.</p>                | <div style="border: 1px solid black; padding: 5px; margin-bottom: 5px;">                 22.11.2012 07:39<br/>                 Unlocked             </div> <div style="display: flex; justify-content: space-around;"> <span style="border: 1px solid black; border-radius: 10px; padding: 2px 10px;">ENTER</span> </div>  |
| <p>2. Select and confirm the menu option "<b>Time Functions</b>".</p>    | <div style="border: 1px solid black; padding: 5px; margin-bottom: 5px;">                 Menu<br/>  Time Functions             </div> <div style="display: flex; justify-content: space-around;"> <span style="border: 1px solid black; border-radius: 10px; padding: 2px 10px;">ENTER</span> </div>   |
| <p>3. Select and confirm menu option "<b>Time Functions Lock 1</b>".</p> | <div style="border: 1px solid black; padding: 5px; margin-bottom: 5px;">                 Time Functions<br/>  Lock 1             </div> <div style="display: flex; justify-content: space-around;"> <span style="border: 1px solid black; border-radius: 10px; padding: 2px 10px;">ENTER</span> </div>   |
| <p>4. Enter and confirm Master Code (or Time Code) of lock 1.</p>        | <div style="border: 1px solid black; padding: 5px; margin-bottom: 5px;">                 Code Lock 1 (MA,TC)<br/>                 -----             </div> <div style="border: 1px solid black; padding: 5px; margin-bottom: 5px;">                 Code Lock 1 (MA,TC)<br/>                 *****             </div> <div style="display: flex; justify-content: space-around;"> <span style="border: 1px solid black; border-radius: 10px; padding: 2px 10px;">ENTER</span> </div> |





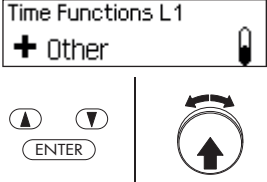
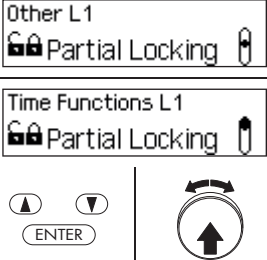
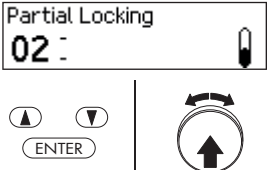



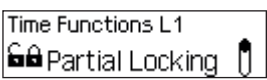

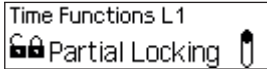
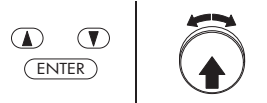
To **set a new Partial Locking Period**, continue with **step 5**.

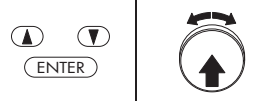
To **change an existing Partial Locking Period**, continue with **step 10**.

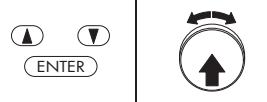
To **delete an existing Partial Locking Period**, continue with **step 15**.

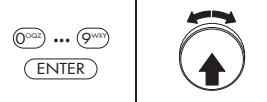
**Setting new Partial Locking Periods**

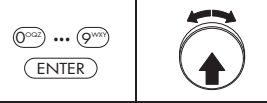
|   |  |
|---|--|
| <p>5. If no Partial Locking Periods have been configured yet, select and confirm the menu option "Time Functions L1 Other".</p>   |   |
| <p>6. Select and confirm menu option "Other L1 Partial Locking" or "Time Functions L1 Partial Locking".</p>   |   |
| <p>7. Select and confirm next unassigned Partial Locking Period (e.g. "Partial Locking 02").</p>  |   |
| <p>8. Set and confirm date and time for the start of the selected Partial Locking Period.</p>   |    |
| <p>9. Set and confirm date and time for the end of the selected Partial Locking Period.</p>   |   |
| <p>The Partial Locking Period is stored.</p> <p>The input unit returns to the menu option "Time Functions L1 Partial Locking". You can now configure additional Partial Locking Periods (repeat steps 5 to 9) or return to the standard mode display.</p> | <br> |

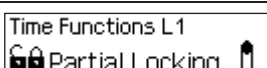
| <b>Changing Partial Locking Periods</b>  |  |
|--|--|
| 10. Select and confirm menu option <b>“Time Functions L1 Partial Locking”</b> .  | <br>     |
| 11. Select and confirm the Partial Locking Period you wish to change.  | <br>     |
| 12. Select and confirm menu option <b>“Change”</b> .   | <br>     |
| 13. Set and confirm new week day and/or new time for the start of the selected Partial Locking Period.   | <br>    |
| 14. Set and confirm new week day and/or new time for the end of the selected Partial Locking Period.   | <br> |
| The changed Partial Locking Period is stored.  |   |
| The input unit returns to the menu option <b>“Time Functions L1 Partial Locking”</b> . You can now change additional Partial Locking Periods (repeat steps 10 to 14) or return to the standard mode display. |   |

| <b>Deleting Partial Locking Periods</b>   |      |
|---|------|
| 15. Select and confirm menu option "Time functions Partial Locking".  |      |
| 16. Select and confirm the Partial Locking Period you wish to delete.   |      |
| 17. Select and confirm menu option "Delete".  |      |
| 18. Confirm deletion.   |      |
| <p>The changed Partial Locking Period is deleted.</p> <p>The input unit returns to the menu option "Time Functions L1 Partial Locking". You can now delete additional Partial Locking Periods (repeat steps 15 to 18) or return to the standard mode display.</p> | <br> |

### 5.3.8 Setting/disabling Opening Delays

The function **Opening Delay** allows you to define how long the opening of the respective lock (door lock 1, last door lock (with Partial Locking) or inner compartment lock) is delayed after entering a valid code or after entering the second valid Opening Code in Dual Mode mode.



- Setting range time delay [mm:ss]:  
**00:00**                      Opening Delay disabled  
**00:01 to 99:59**        1 second to 99 minutes and 59 seconds
- The **Opening Delay is disabled** (set to “00:00”) on delivery.
- The Opening Delay can be defined for door lock 1, the last door lock (only with activated Partial Locking) as well as all inner compartment locks.
- If the code entry is finished when opening a safe compartment with opening delay before the locking period starts but the opening delay ends after the locking period has started the lock opens. This does not apply if a confirmation window is configured. In this case the lock cannot be opened during an ongoing locking period.



#### AS384 Management-Suite Software

In Extended Mode of the locking system with the **code format “PIN only” or “ID+PIN”**, the AS384 Management-Suite Software can also be used to define a **Time-Dependent Opening Delay**. During the specified time, the Time-Dependent Opening Delay overrides the default Opening Delay.

In Extended Mode of the locking system with **code format “ID+PIN”**, the AS384 Management-Suite Software can also be used to define a Code-Related Opening Delay. The code-related Opening Delay overrides the default Opening Delay.

#### Authorization: Master Code, Time Code

**Requirement: System status “Unlocked”** (door locks and door bolt open)

To set or disable the Opening Delay, proceed as follows:

|   |  |
|---|--|
| <p>1. Wake up display (if necessary) and access menu.</p>   |  |
| <p>2. Select and confirm the menu option “Time Functions”.</p>  |  |
| <p>3. Select and confirm menu option time functions of the desired lock (e.g. time functions lock 1).</p> |  |

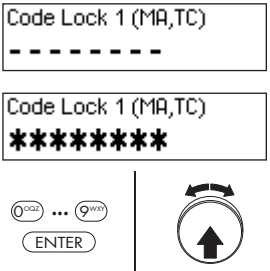
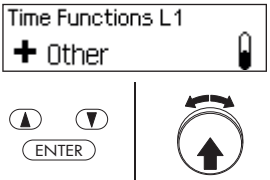
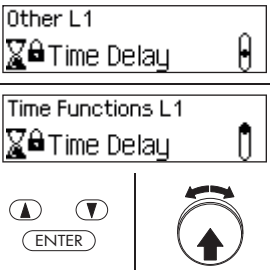
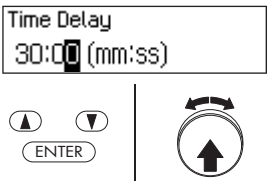
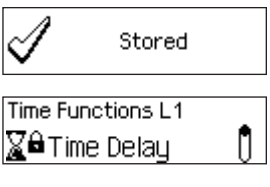

|   |   |
|---|---|
| <p>4. Enter and confirm Master Code (or Time Code) of the selected lock.</p>  |    |
| <p>5. If the Opening Delay is disabled, select and confirm the menu option "Time Functions L1 Other"</p>  |    |
| <p>6. Select and confirm menu option "Other L1 Time Delay" or "Time Functions L1 Time Delay".</p>   |    |
| <p>7. Enter and confirm Opening Delay (mm.ss).<br/>Note: If you want to disable the Opening Delay, enter "00.00".</p>   |   |
| <p>The setting is stored.</p> <p>The input unit returns to the menu option "Time Functions L1 Time Delay". You can now configure other time functions or return to the standard mode display.</p> |  |

### 5.3.9 Setting/Disabling Duress Delays

With the function **Duress Delay**, you can define how long the opening of the respective lock (door lock 1, last door lock (with Partial Locking) or inner compartment lock) is delayed by entering a Duress Code.



- Setting range Duress Delay [mm:ss]:  
**00:00** Duress Delay is disabled  
**00:01 to 99:59** 1 second to 99 minutes and 59 seconds
- The Duress Delay is disabled (set to “00:00”) on delivery.
- The Duress Delay can be defined for door lock 1, the last door lock (only with activated Partial Locking) as well as all inner compartment locks.



#### AS384 Management-Suite Software

In Extended Mode of the locking system with **code format “PIN only” or “ID+PIN”**, the AS384 Management-Suite Software can also be used to define **Time-Dependent Duress Delays**. During the specified time, the Time-Dependent Duress Delay overrides the default Duress Delay.

In Extended Mode of the locking system with **code format “ID+PIN”**, the AS384 Management-Suite Software can also be used to define **Code-Related Duress Delays**. The code-related Duress Delays override the default Duress Delay.

**Authorization: Master Code, Time Code**

**Requirement: System status “Unlocked”** (door locks and door bolt open)

To set or disable the Duress Delay, proceed as follows:

|   |  |
|---|--|
| <p>1. Wake up display (if necessary) and access menu.</p>   |  |
| <p>2. Select and confirm the menu option “<b>Time Functions</b>”.</p>                                     |  |
| <p>3. Select and confirm menu option time functions of the desired lock (e.g. time functions lock 1).</p> |  |

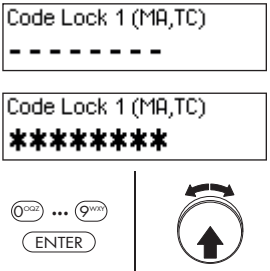
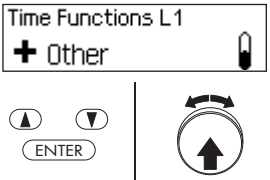
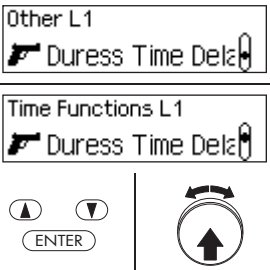
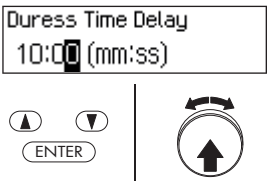
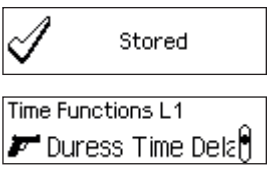
|  |   |
|--|---|
| <p>4. Enter and confirm Master Code (or Time Code) of the selected lock.</p>   |    |
| <p>5. If the Duress Delay is disabled, select and confirm the menu option "Time Functions L1 Other".</p>   |    |
| <p>6. Select and confirm menu option "Other L1 Duress Time Delay" or "Time Functions L1 Duress Time Delay".</p>  |    |
| <p>7. Enter and confirm Duress Delay (mm.ss).<br/>Note: If you want to disable the Duress Delay, enter "00.00".</p>  |   |
| <p>The setting is stored.</p> <p>The input unit returns to the menu option "Time Functions L1 Duress Time Delay". You can now configure other time functions or return to the standard mode display.</p> |  |

### 5.3.10 Setting/disabling the Confirmation Window

With the function **Confirmation Window**, you can prevent the automatic opening of the respective lock (door lock 1, last door lock (with Partial Locking) or inner compartment lock) after an Opening Delay has elapsed.

If the Confirmation Window is activated (time >00.00), a valid Opening Code must be entered again within the specified time after expiry of the Opening Delay. If a valid Opening Code is not entered in the Confirmation Window, the opening is automatically cancelled.



- Setting range Confirmation Window [mm:ss]:  
**00:00** Confirmation Window disabled  
**00:01 to 99:59** 1 second to 99 minutes and 59 seconds
- The Confirmation Window is disabled (set to "00:00") on delivery.
- The Confirmation Window can be defined for door lock 1, the last door lock (only with activated Partial Locking) as well as all inner compartment locks.

**Authorization: Master Code, Time Code**

**Requirement: System status "Unlocked"** (door locks and door bolt open)

To set or disable the Confirmation Window, proceed as follows:

|   |  |
|---|--|
| <p>1. Wake up display (if necessary) and access menu.</p>   |  |
| <p>2. Select and confirm the menu option "<b>Time Functions</b>".</p>   |  |
| <p>3. Select and confirm menu option time functions of the desired lock (e.g. time functions lock 1).</p>       |  |
| <p>4. Enter and confirm Master Code (or Time Code) of the selected lock.</p>                                    |  |
| <p>5. If the Confirmation Window is disabled, select and confirm the menu option "Time Functions L1 Other".</p> |  |

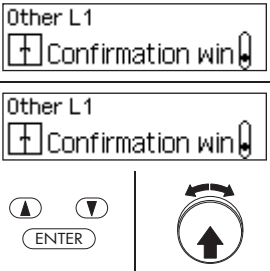
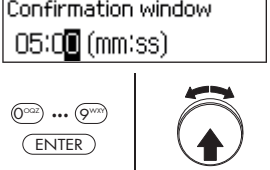
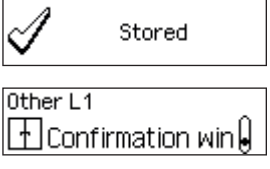
|   |   |
|---|---|
| <p>6. Select and confirm menu option <b>“Other L1 Confirmation wind.”</b> or <b>“Time Functions L1 Confirmation wind.”</b>.</p>   |  |
| <p>7. Enter and confirm confirmation period (mm.ss).<br/>Note: If you want to disable the Confirmation Window, enter “00.00”.</p>   |  |
| <p>The setting is stored.</p> <p>The input unit returns to the menu option “Time Functions L1 Confirmation wind.”. You can now configure other time functions or return to the standard mode display.</p> |  |

### 5.3.11 Setting/disabling the Return Lock

With the function **Return Lock**, you can specify how long the safe/inner compartment can not be opened after each closing. If the Return Lock is activated (time > 0), the Return Locking period starts to run as soon as the locks are closed. The safe can not be opened again until the Return Lock period has elapsed.









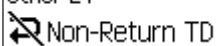
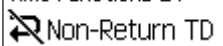

- Setting range of Return Lock [mm]:  
**000** Return Lock disabled  
**001 to 240** 1 minute to 240 minutes
- The Return Lock is disabled (set to "00:00") on delivery.
- The Return Lock can be defined for door lock 1, the last door lock (only with activated Partial Locking) as well as all inner compartment locks.

**Authorization: Master Code, Time Code**

**Requirement: System status "Unlocked"** (door locks and door bolt open)

To set or disable the Return Lock, proceed as follows:

|   |  |
|---|--|
| <p>1. Wake up display (if necessary) and access menu.</p>   |  |
| <p>2. Select and confirm the menu option "Time Functions".</p>  |  |
| <p>3. Select and confirm menu option time functions of the desired lock (e.g. time functions lock 1).</p> |  |
| <p>4. Enter and confirm Master Code (or Time Code) of the selected lock.</p>                              |  |
| <p>5. If the Return Lock is disabled, select and confirm the menu option "Time Functions L1 Other".</p>   |  |

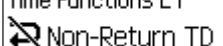
|  |  |
|--|--|
| <p>6. Select and confirm menu option <b>“Other L1 Non-Return TD”</b> or <b>“Time Functions L1 Non-Return TD”</b>.</p>  | <div style="border: 1px solid black; padding: 2px; margin-bottom: 2px;">             Other L1<br/>  </div> <div style="border: 1px solid black; padding: 2px;">             Time Functions L1<br/>  </div> <div style="display: flex; justify-content: space-around; align-items: center; margin-top: 5px;"> <div style="text-align: center;">  <br/>             ENTER         </div> <div style="text-align: center;">  </div> </div> |
| <p>7. Enter and confirm Return Lock Period (mm.ss).<br/>                 Note: If you want to disable the Return Lock, enter “00.00”.</p>  | <div style="border: 1px solid black; padding: 2px; margin-bottom: 2px;">             Non-Return TD<br/>             06.00 (mmm)         </div> <div style="display: flex; justify-content: space-around; align-items: center; margin-top: 5px;"> <div style="text-align: center;">  <br/>             ENTER         </div> <div style="text-align: center;">  </div> </div>   |
| <p>The defined Return Locking Period is stored.</p> <p>The input unit returns to the menu option “Time Functions L1 Non-Return TD”. You can now configure other time functions or return to the standard mode display.</p> | <div style="border: 1px solid black; padding: 2px; margin-bottom: 2px;">  Stored         </div> <div style="border: 1px solid black; padding: 2px;">             Time Functions L1<br/>  </div>  |

### 5.3.12 Setting, changing and deleting Summer/Winter Time Changeover

With the function **Summer/Winter Time**, you can set, change and delete the start and end of summer time.



- Ex factory the Summer/Winter Changeover is enabled and set to time zone rule MESZ.
- The Summer/Winter Changeover can only be defined in the settings for lock 1 and is valid for the entire locking system.
- If "manual" mode is activated the Summer/Winter Changeover must be adjusted each year to the corresponding changeover data.
- The Summer/Winter Changeover must be set at least 1 hour before it takes place.
- A change from automatic to manual Summer/Winter Changeover cannot be switched back any longer. A switch back is possible only by resetting the lock system.



#### AS384 Management-Suite Software

In Extended Mode of the locking system, the Summer/Winter Changeover Time can be defined with the AS384 Management-Suite Software, by means of time zone rules or by fixed dates and times for the start and end of summer time

**Authorization: Master Code "MA1", Time Code "TC1"**

**Requirement: System status "Unlocked"** (door locks and door bolt open)



To set, change or delete Summer/Winter Changeover Time, proceed as follows:

|   |   |
|---|---|
| <p>1. Wake up display (if necessary) and access menu.</p>         | <div style="border: 1px solid black; padding: 5px; margin-bottom: 5px;">                 22.11.2012 07:39<br/>                 Unlocked             </div> <div style="display: flex; justify-content: space-around; align-items: center;"> <span style="border: 1px solid black; border-radius: 10px; padding: 2px 10px;">ENTER</span> </div>  |
| <p>2. Select and confirm the menu option "Time Functions".</p>    | <div style="border: 1px solid black; padding: 5px; margin-bottom: 5px;">                 Menu<br/>  Time Functions             </div> <div style="display: flex; justify-content: space-around; align-items: center;"> <div style="display: flex; gap: 5px;"> <span style="font-size: 12px;">▲</span> <span style="font-size: 12px;">▼</span> </div> <span style="border: 1px solid black; border-radius: 10px; padding: 2px 10px;">ENTER</span> </div>   |
| <p>3. Select and confirm menu option "Time Functions Lock 1".</p> | <div style="border: 1px solid black; padding: 5px; margin-bottom: 5px;">                 Time Functions<br/>  Lock 1  </div> <div style="display: flex; justify-content: space-around; align-items: center;"> <span style="border: 1px solid black; border-radius: 10px; padding: 2px 10px;">ENTER</span> </div>  |
| <p>4. Enter and confirm Master Code (or Time Code) of lock 1.</p> | <div style="border: 1px solid black; padding: 5px; margin-bottom: 5px;">                 Code Lock 1 (MA,TC)<br/>                 -----             </div> <div style="border: 1px solid black; padding: 5px; margin-bottom: 5px;">                 Code Lock 1 (MA,TC)<br/>                 *****             </div> <div style="display: flex; justify-content: space-around; align-items: center;"> <div style="display: flex; gap: 5px;"> <span style="font-size: 12px;">⏪</span> <span style="font-size: 12px;">...</span> <span style="font-size: 12px;">⏩</span> </div> <span style="border: 1px solid black; border-radius: 10px; padding: 2px 10px;">ENTER</span> </div> |



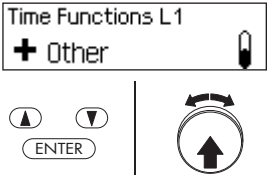
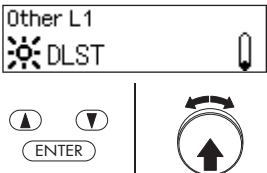
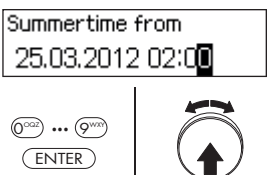

To **set the Summer/Winter Changeover Time**, proceed to **step 5**.  
 To **change the Summer/Winter Changeover Time**, proceed to **step 9**.  
 To **delete the Summer/Winter Changeover Time**, proceed to **step 14**.

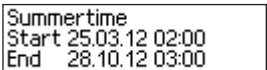

**Setting (enabling) the Summer/Winter Changeover Time**

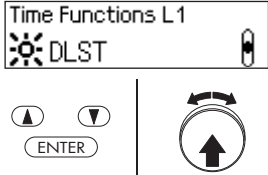
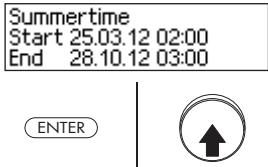
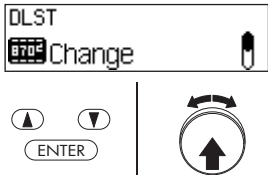
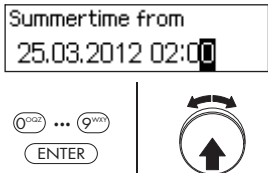
|  |   |
|--|---|
| <p>5. Select and confirm the menu option "Time Functions L1 Other".</p>            |    |
| <p>6. Select and confirm menu option "Other L1 DLST".</p>                          |    |
| <p>7. Set and confirm date and time for the start of the selected summer time.</p> |    |
| <p>8. Set and confirm date and time for the end of the selected summer time.</p>   |   |
| <p>The settings have been stored.</p>  |  |
| <p>The set dates for the summer/winter time changeover are displayed.</p>          |  |

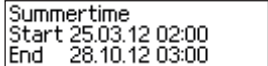
**Changing the Summer/Winter Changeover Time**

|  |   |
|--|---|
| <p>9. Select and confirm menu option <b>"Time Functions L1 DLST"</b>.</p>                          |    |
| <p>10. Confirm display with the set dates for the summer/winter time changeover.</p>               |    |
| <p>11. Select and confirm menu option <b>"Change"</b>.</p>   |    |
| <p>12. Set and confirm new week day and/or new time for the start of the selected summer time.</p> |   |
| <p>13. Set and confirm new week day and/or new time for the end of the selected summer time.</p>   |  |
| <p>The changed Summer/Winter Changeover Time is stored.</p>  |  |
| <p>The set dates for the Summer/Winter Changeover Time are displayed.</p>                          |  |

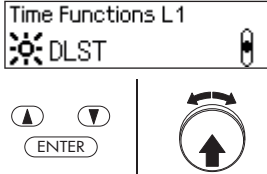
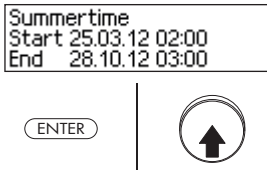
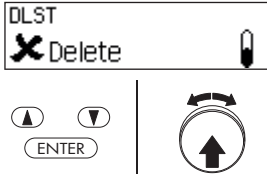
**Deleting (disabling) Summer/Winter Changeover Time**

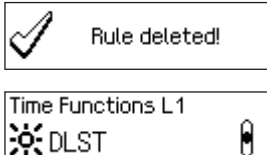
|  |   |
|--|---|
| <p>14. Select and confirm menu option <b>“Time Functions L1 DLST”</b>.</p>   |    |
| <p>15. Confirm display with the set dates for the summer/winter time changeover.</p>   |    |
| <p>16. Select and confirm menu option <b>“Delete”</b>.</p>   |    |
| <p>17. Confirm deletion.</p>   |   |
| <p>The Summer/Winter Time Changeover is deleted or disabled.<br/><br/>The input unit returns to the menu option <b>“Time functions S1 DLST”</b>.</p> |  |

## 5.4 Settings

### 5.4.1 General information on the settings

In the menu “**Settings**” you can define different basic settings for the locks (e.g. default Fast Locking time, default Time Lock Delay, etc.) and set the input unit (e.g. dialog language, volume, etc.). The following tables provide an overview of the functions and where they can be set.

| Settings locks   | Door lock 1 | Other door locks | Inner compartment locks |
|------------------|-------------|------------------|-------------------------|
| Required code    | MA1 or TC1  | MA... or TC...   | MA... or TC...          |
| Duress Code      | ✓ * ****    | ---              | ---                     |
| Fast Locking     | ✓ *         | ---              | ---                     |
| Time Lock Delay  | ✓ *         | ---              | ---                     |
| Date/Time Format | ✓ *         | ---              | ---                     |
| Lock Period End  | ✓ *         | ---              | ---                     |
| Locking Mode     | ✓           | ---              | ---                     |
| Remote Lock      | ✓ *         | ---              | ---                     |
| Parallel Mode    | ✓ * ****    | ---              | ---                     |
| Dual Mode        | ✓ **        | ✓ **             | ✓ **                    |
| Max. Open Period | ✓ *         | ---              | ---                     |

\* Settings are valid for the entire locking system

\*\* Setting can be set individually for each lock

\*\*\* The Parallel Mode can only be enabled and disabled when all individual codes are reset to the factory setting.

\*\*\*\* **Important:** With the AS384 Management-Suite Software, the structure of the Duress Code can be modified. As standard the Duress Code is activated and set to opening code+3.

| Settings input unit         | Required code                   |
|-----------------------------|---------------------------------|
| Language                    | No code needed                  |
| Volume                      | <b>MA1 (Master Code lock 1)</b> |
| Lighting                    | No code needed                  |
| Contrast                    | No code needed                  |
| Battery compartment content | <b>MA1 (Master Code lock 1)</b> |

## 5.4.2 Define basic settings for the locks

### 5.4.2.1 Enabling/disabling Duress Code

The function **Duress Code** allows you to define whether the locking system recognizes a Duress Code (function enabled) or not (function disabled).







- The Duress Code is enabled on delivery.
- The Duress Code function can only be enabled or disabled in the settings for lock 1, and is valid for the entire locking system.

**Authorization:** Master Code "MA1"

**Requirement:** System status "Unlocked" (door locks and door bolt open)

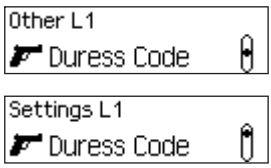
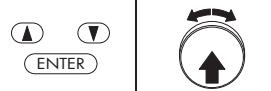
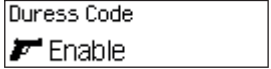
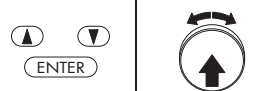
To enable or disable the Duress Code function, proceed as follows:

|  |  |
|--|--|
| <p>1. Wake up display (if necessary) and access menu.</p>  |  |
| <p>2. Select and confirm the menu option "Settings".</p>   |  |
| <p>3. Select and confirm menu option "Settings Lock 1".</p>  |  |
| <p>4. Enter and confirm Master Code of lock 1.</p>   |  |
| <p>5. If the Duress Code function is disabled, select and confirm the menu option "Settings L1 Other".</p> |  |

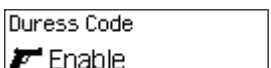
|  |   |
|--|---|
| <p>6. Select and confirm menu option <b>“Other L1 Duress Code”</b> or <b>“Settings L1 Duress Code”</b>.</p>  | <br>  |
| <p>7. Select and confirm menu option <b>“Duress Code Enable”</b>.</p>  | <br>  |
| <p>8. Select and confirm desired setting.</p> <ul style="list-style-type: none"> <li>– <b>On</b>: Enable Duress Code function</li> <li>– <b>Off</b>: Disable Duress Code function</li> </ul> | <br><br> |
| <p>The selected setting is stored.</p> <p>The input unit returns to the menu option <b>“Enable Duress Code”</b>.</p>   | <br>   |

### 5.4.2.2 Setting Fast Locking times

The function **Fast Locking** allows you to specify the default value for the Fast Locking time that appears in the Fast Locking activation dialog (see section 4.7 "Enabling Fast Locking"). The default value can be changed by the user in the activation dialog and is then stored as a new default value for the next Fast Locking process.



- Setting range of Fast Locking [hhh:mm]:  
**000:00** Fast Locking disabled  
**000:01 to 144:00** 1 minute to 144 hours
- On delivery, the Fast Locking is **deactivated**.
- The standard value for the Fast Locking period can only be defined in the settings for lock 1 and is valid for the entire locking system.

**Authorization:** Master Code "MA1", Time Code "TC1"

**Requirement:** System status "Unlocked" (door locks and door bolt open)  
 System status "Secured" (door locks and door lock closed)

To set or change the Fast Locking period, proceed as follows:

|   |  |
|---|--|
| <p>1. Wake up display (if necessary) and access menu.</p>   |  |
| <p>2. Select and confirm the menu option "Settings".</p>  |  |
| <p>3. Select and confirm menu option "Settings Lock 1".</p>   |  |
| <p>4. Enter and confirm Master Code (or Time Code) of lock 1.</p>   |  |
| <p>5. If the Fast Locking function is disabled, select and confirm the menu option "Settings L1 Other".</p> |  |

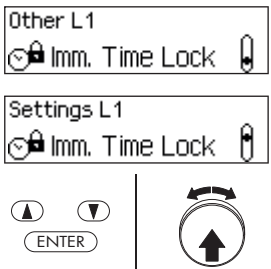
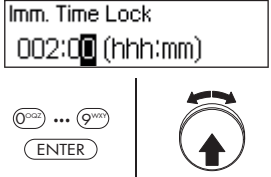
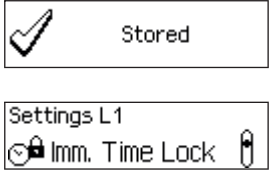
|  |   |
|--|---|
| <p>6. Select and confirm menu option <b>“Other L1 Imm. Time Lock”</b> or <b>“Settings L1 Imm. Time Lock”</b>.</p>  |  |
| <p>7. Set and confirm desired Fast Locking period.</p>   |  |
| <p>The setting is stored.</p> <p>The input unit returns to the menu option <b>“Settings L1 Imm. Time Lock”</b>. You can now configure other settings or return to the standard mode display.</p> |  |



### 5.4.2.3 Setting a Time Lock Delay

The function Time Lock Delay is used to set the Time Lock Delay, which appears as the default value in the activation dialog Time Lock Delay (see section 4.8 "Enabling a Time Lock Delay"). The default value can be changed by the user in the activation dialog and is then stored as a new default value for the next Time Lock Delay.





- Setting range of Time Lock Delay [mmm]:  
**000** Time Lock Delay disabled  
**000 to 240** 1 minute to 240 minutes
- On delivery, the **Time Lock Delay is disabled (0 minutes)**.
- The Time Lock Delay can only be defined in the settings for lock 1 and is valid for the entire locking system.

**Authorization:** Master Code "MA1", Time Code "TC1"

**Requirement:** System status "Unlocked" (door locks and door bolt open)  
 System status "Secured" (door locks and door lock closed)

To set the Time Lock Delay time, proceed as follows:

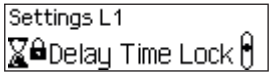
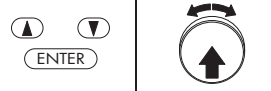
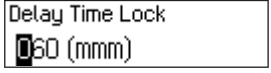
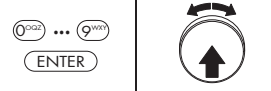
|  |  |
|--|--|
| <p>1. Wake up display (if necessary) and access menu.</p>  |  |
| <p>2. Select and confirm the menu option "Settings".</p>   |  |
| <p>3. Select and confirm menu option "Settings Lock 1".</p>  |  |
| <p>4. Enter and confirm Master Code (or Time Code) of lock 1.</p>  |  |
| <p>5. If the Time Lock Delay function is disabled, select and confirm the menu option "Settings L1 Other".</p> |  |

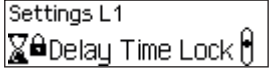
|   |   |
|---|---|
| <p>6. Select and confirm menu option <b>“Other L1 Delay Time Lock”</b> or <b>“Settings L1 Delay Time Lock”</b>.</p>   |    |
| <p>7. Set and confirm desired Fast Locking period.</p>  |     |
| <p>The setting is stored.</p> <p>The input unit returns to the menu option <b>“Settings L1 Delay Time Lock”</b>. You can now configure other settings or return to the standard mode display.</p> |     |

### 5.4.2.4 Setting the date and time format

The function Date/Time Format allows you to set the format for the date and time display of the input unit.



- The following date/time formats are available:
  - "dd.mm.yyyy 24 h": Date (day/month/year), time (24 hours)
  - "dd.mm.yyyy 12 h": Date (day/month/year), time (12 hours)
  - "mm/dd/yyyy 24 h": Date (month/day/year), time (24 hours)
  - "mm/dd/yyyy 12 h": Date (month/day/year), time (12 hours)
- On delivery, the **Date/Time Format** is set to **"dd.mm.yyyy 24 h"**.
- The Date/Time Format can only be defined in the settings for lock 1 and is valid for the entire locking system.

**Authorization:** Master Code "MA1", Time Code "TC1"

**Requirement:** System status "Unlocked" (door locks and door bolt open)

To set the date and time format, proceed as follows:

|    |   |  |
|----|---|--|
| 1. | Wake up display (if necessary) and access menu.         |  |
| 2. | Select and confirm the menu option "Settings".          |  |
| 3. | Select and confirm menu option "Settings Lock 1".       |  |
| 4. | Enter and confirm Master Code (or Time Code) of lock 1. |  |
| 5. | Select and confirm "Settings Date/Time format".         |  |

|  |  |
|--|--|
| <p>6. Select and confirm desired date and time format.</p>   | <div style="border: 1px solid black; padding: 2px; margin-bottom: 2px;">Date/Time Format<br/><input checked="" type="radio"/> dd.mm.yyyy 24h </div> <div style="border: 1px solid black; padding: 2px; margin-bottom: 2px;">Date/Time Format<br/><input type="radio"/> dd.mm.yyyy 12h </div> <div style="border: 1px solid black; padding: 2px; margin-bottom: 2px;">Date/Time Format<br/><input type="radio"/> mm.dd.yyyy 24h </div> <div style="border: 1px solid black; padding: 2px; margin-bottom: 2px;">Date/Time Format<br/><input type="radio"/> mm.dd.yyyy 12h </div> <div style="display: flex; justify-content: space-around; align-items: center;"> <div style="text-align: center;"> <br/> <br/>             ENTER         </div> <div style="text-align: center;"> </div> </div> |
| <p>The setting is stored.</p> <p>The input unit returns to the menu option "Settings Date/Time form". You can now configure other settings or return to the standard mode display.</p> | <div style="border: 1px solid black; padding: 2px; margin-bottom: 2px;">  Stored         </div> <div style="border: 1px solid black; padding: 2px;">             Settings L1<br/> <math>\frac{12}{24}</math> Date/Time Format  </div>  |

### 5.4.2.5 Setting the Locking Mode

The function Locking Mode allows you to define whether the locks close automatically after closing the door bolt or whether the closing process must be confirmed with the key <Enter> or by pressing the dial knob.



- On delivery, the **Locking Mode is set to "Automatic"**.
- Unless required for technical reasons, the Locking Mode should be left on "automatic".
- The Locking Mode can only be defined in the settings for lock 1 and is valid for the entire locking system.

**Authorization:** Master Code "MA1"

**Requirement:** System status "Unlocked" (door locks and door bolt open)

To set the Locking Mode, proceed as follows:

|  |  |
|--|--|
| <p>1. Wake up display (if necessary) and access menu.</p>            |  |
| <p>2. Select and confirm the menu option "Settings".</p>             |  |
| <p>3. Select and confirm menu option "Settings Lock 1".</p>          |  |
| <p>4. Enter and confirm Master Code of lock 1.</p>                   |  |
| <p>5. Select and confirm menu option "Settings S1 Locking Mode".</p> |  |

|  |  |
|--|--|
| <p>6. Select and confirm desired setting.</p> <ul style="list-style-type: none"> <li>- <b>Automatic:</b> Locks are automatically closed after closing the door bolt</li> <li>- <b>Manual:</b> After closing the door bolt, the &lt;ENTER&gt; button must be pressed before the locks close.</li> </ul> | <div style="border: 1px solid black; padding: 5px; margin-bottom: 5px;">             Locking mode<br/> <input checked="" type="radio"/> Automatic  </div> <div style="border: 1px solid black; padding: 5px;">             Locking mode<br/> <input type="radio"/> Manual  </div> <div style="display: flex; justify-content: space-around; align-items: center; margin-top: 5px;"> <div style="text-align: center;"> <br/>             ENTER         </div> <div style="text-align: center;"> </div> </div> |
| <p>The selected Locking Mode is stored.</p> <p>The input unit returns to the menu option “Settings S1 Fast Locking”. You can now configure other settings or return to the standard mode display.</p>  | <div style="border: 1px solid black; padding: 5px; margin-bottom: 5px;">  Stored         </div> <div style="border: 1px solid black; padding: 5px;">             Settings L1<br/> <input type="radio"/> Locking mode  </div>   |

### 5.4.2.6 Enabling/disabling the Show time lock end

With the function **Show time lock end** you can determine whether the status display of the input unit displays the date and time of the end of the locking period (function enabled) or the current date and time (function disabled).





- The default factory setting for the function Show time lock end is enabled.
- The function Show time lock end can only be defined in the settings for lock 1 and is valid for the entire locking system.
- With <CLR> actual time of day can be displayed.

**Authorization:** Master Code "MA1"

**Requirement:** System status "Unlocked" (door locks and door bolt open)

To enable or disable the function Show time lock end, proceed as follows:

|  |  |
|--|--|
| <p>1. Wake up display (if necessary) and access menu.</p>                  |  |
| <p>2. Select and confirm the menu option "Settings".</p>                   |  |
| <p>3. Select and confirm menu option "Settings Lock 1".</p>                |  |
| <p>4. Enter and confirm Master Code of lock 1.</p>                         |  |
| <p>5. Select and confirm menu option "Settings L1 Show time lock end".</p> |  |

|  |   |
|--|---|
| <p>6. Select and confirm desired setting.</p> <ul style="list-style-type: none"> <li>- <b>On:</b> Enable function Show time lock end</li> <li>- <b>Off:</b> Disable function Show time lock end</li> </ul> | <div style="border: 1px solid black; padding: 2px; margin-bottom: 2px;">             Show time lock end<br/> <input type="radio"/> Off         </div> <div style="border: 1px solid black; padding: 2px; margin-bottom: 2px;">             Show time lock end<br/> <input checked="" type="radio"/> On         </div> <div style="display: flex; justify-content: space-around; align-items: center;"> <div style="text-align: center;"> <input type="button" value="▲"/> <input type="button" value="▼"/><br/> <input type="button" value="ENTER"/> </div> <div style="text-align: center;">  </div> </div> |
| <p>The selected setting is stored.</p> <p>The input unit returns to the menu option "Settings L1 Show time lock end". You can now configure other settings or return to the standard mode display.</p>     | <div style="border: 1px solid black; padding: 2px; margin-bottom: 2px;">  Stored         </div> <div style="border: 1px solid black; padding: 2px;">             Settings L1<br/> <input checked="" type="radio"/> Show time lock e         </div>   |



### 5.4.2.7 Enabling/disabling the Remote Lock function

The function of **Remote Lock** allows you to determine whether remote locking can be triggered (enabled) via a remote locking contact connected to the corresponding input of the I/O-Box (by default input 1) or not (function disabled).



- Remote Lock is disabled on delivery.
- If your system does not have an I/O-Box or IP-Box, this function has no effect.
- The function Remote Lock can only be enabled or disabled in the settings for lock 1 and is valid for the entire locking system.
- As standard the Remote Lock function is monitored against sabotage. This setting may only be changed via the AS384 Management-Suite Software.
- The resistive circuit for sabotage surveillance, e.g. when connecting to a hazard alert is described in the installation instructions.



#### AS384 Management-Suite Software

In Extended Mode of the locking system, the AS384 Management-Suite Software can be used to assign the function Remote Lock to an input other than 1.

**Authorization: Master Code "MA1"**

**Requirement: System status "Unlocked"** (door locks and door bolt open)

To enable or disable the function Remote Lock, proceed as follows:

|    |   |  |
|----|---|--|
| 1. | Wake up display (if necessary) and access menu.           |  |
| 2. | Select and confirm the menu option <b>"Settings"</b> .    |  |
| 3. | Select and confirm menu option <b>"Settings Lock 1"</b> . |  |
| 4. | Enter and confirm Master Code of lock 1.                  |  |

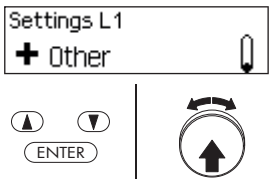
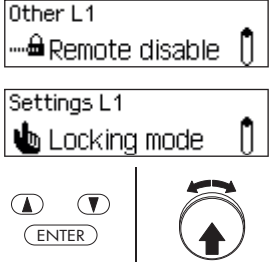
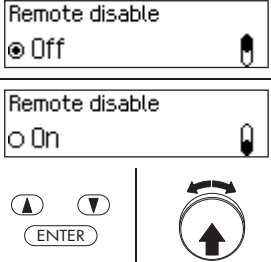
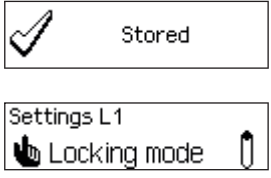
|   |  |
|---|--|
| <p>5. If the function Remote Lock is disabled, select and confirm the menu option "Settings L1 Other".</p>  |   |
| <p>6. Select and confirm menu option "<b>Other L1 Remote Lock</b>" or "<b>Settings S1 Remote Lock</b>".</p>   |   |
| <p>7. Select and confirm desired setting.</p> <ul style="list-style-type: none"> <li>- <b>On:</b> Enable Remote Lock</li> <li>- <b>Off:</b> Disable Remote Lock</li> </ul>                      |   |
| <p>The selected setting is stored.</p> <p>The input unit returns to the menu option "Settings S1 Remote Lock". You can now configure other settings or return to the standard mode display.</p> |  |

### 5.4.2.8 Enabling/disabling Parallel Mode

The function **Parallel Mode** allows you to determine whether the door locks operated in Parallel Mode (enabled) or not (function disabled).



- In the factory settings the Parallel Mode is disabled.
- The Parallel Mode can only be enabled and disabled when all locks are reset to the factory setting. Otherwise, an error message appears during the activation or deactivation.
- The Parallel Mode is only valid for the door locks. Inner compartment locks can not be operated in Parallel Mode.
- In Parallel Mode enabled, the Opening Codes for all door locks are identical. In other words, a code change leads to the identical change of the corresponding Opening Codes in all locks.  
If door lock 1 is opened with the Opening Code OCap in Parallel Mode enabled, all valid Opening Codes can be used for the second door lock, except OCap. For opening any further door locks, all valid Opening Codes can be used, except the previously used Opening Code.
- The Parallel Mode can only enabled or disabled in the settings for lock 1 and is valid for all other door locks.

**Authorization:** Factory code OCa1 "10203040" (or "0010203040" with ID+PIN mode)

**Requirement:** System status 'Unlocked' (door locks and door bolt open) and system reset to factory settings and addressed.

To enable or disable the function Parallel Mode, proceed as follows:

|  |  |
|--|--|
| 1. Wake up display (if necessary) and access menu.   |  |
| 2. Select and confirm the menu option "Settings".    |  |
| 3. Select and confirm menu option "Settings Lock 1". |  |
| 4. Enter and confirm Master Code of lock 1.          |  |

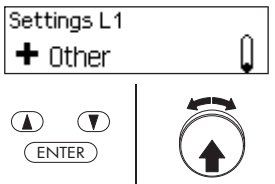
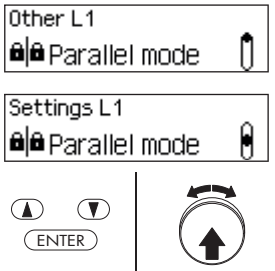
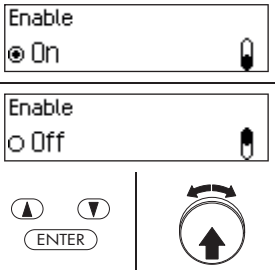
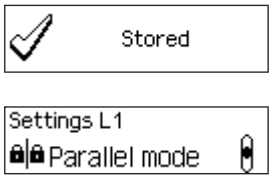
|   |  |
|---|--|
| <p>5. If the function Parallel Mode is disabled, select and confirm the menu option "Settings L1 Other".</p>  |   |
| <p>6. Select and confirm menu option "<b>Other L1 Parallel Mode</b>" or "<b>Settings S1 Parallel Mode</b>".</p>   |   |
| <p>7. Select and confirm desired setting.</p> <ul style="list-style-type: none"> <li>- <b>On</b>: Enable Parallel Mode</li> <li>- <b>Off</b>: Disable Parallel Mode</li> </ul>                    |   |
| <p>The selected setting is stored.</p> <p>The input unit returns to the menu option "Settings S1 Parallel Mode". You can now configure other settings or return to the standard mode display.</p> |  |

### 5.4.2.9 Enabling/disabling Dual Mode

The function **Dual Mode** allows you to determine whether two valid codes are needed to open a lock (function enabled) or only one valid code (function disabled).







- In the factory settings, Dual Mode mode is disabled.
- The Dual Mode must be set for each lock individually. In order to activate Dual Mode in the menu two opening codes must have been created already for the appropriate lock.

**Authorization: Master Code**

**Requirement: System status "Unlocked"** (door locks and door bolt open)

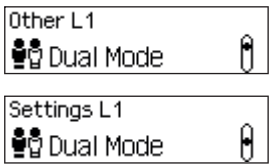
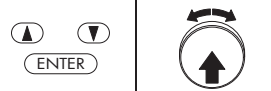
To enable or disable the function Dual Mode, proceed as follows:

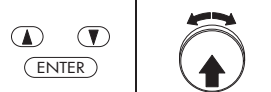
|  |  |
|--|--|
| <p>1. Wake up display (if necessary) and access menu.</p>  |  |
| <p>2. Select and confirm the menu option "Settings".</p>   |  |
| <p>3. Select and confirm the menu option settings for the desired lock.</p>                              |  |
| <p>4. Enter and confirm Master Code of the selected lock.</p>  |  |
| <p>5. If the function Dual Mode is disabled, select and confirm the menu option "Settings L1 Other".</p> |  |

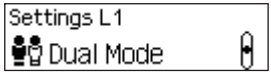
|   |   |
|---|---|
| <p>6. Select and confirm menu option “<b>Other L1 Dual Mode</b>” or “<b>Settings S1 Dual Mode</b>”.</p>   | <br>  |
| <p>7. Select and confirm desired setting.</p> <ul style="list-style-type: none"> <li>- <b>On</b>: Enable Dual Mode</li> <li>- <b>Off</b>: Disable Dual Mode</li> </ul>                        | <br><br> |
| <p>The selected setting is stored.</p> <p>The input unit returns to the menu option “Settings S1 Dual Mode”. You can now configure other settings or return to the standard mode display.</p> | <br>  |

### 5.4.2.10 Setting the Maximum Open Period

The function Maximum Open Period allows you to determine how long the door can remain open until a forced closure is triggered. As soon as the Maximum Open Period has elapsed, an intermittent beep sounds when the door locks are open until the system is secured (boltwork closes).





- Setting range of Maximum Open Period [mm:ss]:  
**00:00** Maximum Open Period disabled  
**00:01 to 99:59** 1 second to 99 minutes and 59 seconds
- On delivery, the Maximum **Open Period is disabled** (setting "00:00")
- The Maximum Open Period is available only in the settings for lock 1 and is valid for the entire locking system.
- The setting is taken over with next opening only.
- The Maximum Open Period does not apply to the inner compartment locks.

**Authorization:** Master Code "MA1", Time Code "TC1"

**Requirement:** System status "Unlocked" (door locks and door bolt open)

To set the Maximum Open Period, proceed as follows:

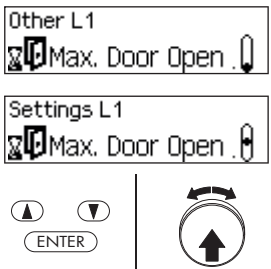
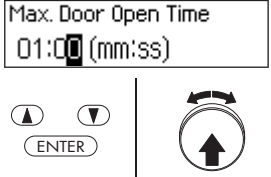
|  |  |
|--|--|
| <p>1. Wake up display (if necessary) and access menu.</p>  |  |
| <p>2. Select and confirm the menu option "Settings".</p>   |  |
| <p>3. Select and confirm menu option "Settings Lock 1".</p>  |  |
| <p>4. Enter and confirm Master Code of lock 1.</p>   |  |
| <p>5. If the function Maximum Open Period is disabled, select and confirm the menu option "Settings L1 Other".</p> |  |

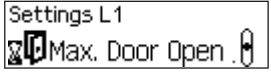
|   |  |
|---|--|
| <p>6. Select and confirm menu option <b>“Other L1 Max. Open Period”</b> or <b>“Settings S1 Max. Open Period”</b>.</p>   |   |
| <p>7. Enter and confirm desired Maximum Open Period (format: mm:ss).<br/>Note: If you want to disable the maximum opening period, enter “00.00”.</p>  |   |
| <p>The setting is stored.</p> <p>The input unit returns to the menu option “Settings S1 Max. Open Period”. You can now configure other settings or return to the standard mode display.</p> | <br> |



### 5.4.3 Defining basic settings for the input unit

#### 5.4.3.1 Setting the dialog language, brightness and contrast of the display



The dialog language as well as the brightness and contrast of the display can be changed at any time via the corresponding menu points in the unlocked menu or in the secured menu. This requires no code input.

**Authorization:** no code required

**Requirement:** System status "Unlocked" (door locks and door bolt open)

To set the dialog language, brightness and contrast of the display, proceed as follows:

|   |  |
|---|--|
| <p>1. Wake up display (if necessary) and access menu.</p>       |  |
| <p>2. Select and confirm the menu option "Settings".</p>        |  |
| <p>3. Select and confirm menu option "Settings Input Unit".</p> |  |

To **change the dialog language**, continue with **step 4**.  
 To **change the brightness of the display**, continue with **step 6**.  
 To **change the contrast of the display**, continue with **step 8**.

#### Changing the dialog language

|   |  |
|---|--|
| <p>4. Select and confirm menu option "Input Unit Language".</p> |  |
| <p>5. Select and confirm desired language.</p>                  |  |
| <p>The setting is stored.</p>                                   |  |

The input unit returns to the menu option "Input unit language". You can now configure other settings or return to the standard mode display.

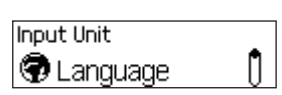

**Changing the brightness**

6. Select and confirm menu option "Input Unit Brightness".

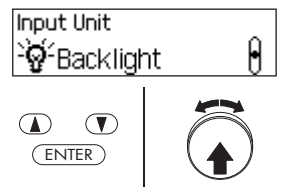

7. Adjust the desired brightness and confirm (setting range: 0 (Off), 1...5).

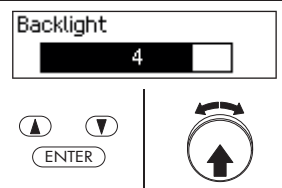

The setting is stored.



The input unit returns to the menu option "Input unit brightness". You can now configure other settings or return to the standard mode display.



**Changing the contrast**

8. Select and confirm menu option "Input Unit Contrast".

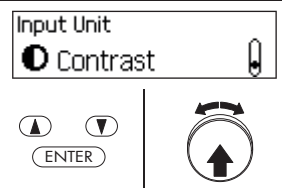

9. Adjust desired contrast and confirm (setting range: 1...10).

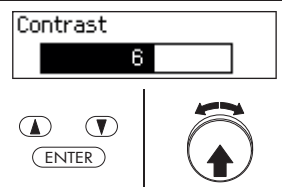

The setting is stored.



The input unit returns to the menu option "Input Unit Contrast". You can now configure other settings or return to the standard mode display.



### 5.4.3.2 Setting the signal volume



The signal volume is available only in the setting menu of the input unit.

**Authorization:** Master Code "MA1"

**Requirement:** System status "Unlocked" (door locks and door bolt open)

To set the signal volume, proceed as follows:

|  |  |
|--|--|
| <p>1. Wake up display (if necessary) and access menu.</p>  |  |
| <p>2. Select and confirm the menu option "Settings".</p>   |  |
| <p>3. Select and confirm menu option "Settings Input Unit".</p>  |  |
| <p>4. Select and confirm menu option "Input Unit Volume".</p>  |  |
| <p>5. Enter and confirm Master Code of lock 1.</p>   |  |
| <p>6. Adjust the desired volume and confirm (setting range: 0 (Off), 1...5).</p>   |  |
| <p>The setting is stored.</p>  |  |
| <p>The input unit returns to the menu option "Input Unit Volume". You can now configure other settings or return to the standard mode display.</p> |  |

### 5.4.3.3 Setting the content of the battery compartment

In principle, the locking system control automatically recognizes whether the system is connected to an external voltage source (possible only with option I/O-Box), if the battery compartment is empty or if batteries or a rechargeable battery pack have been inserted.

If for some reason the battery compartment content is not properly recognized (see table below), you can change the type of power supply via the setting "Power". It is essential to note and follow the following instructions.

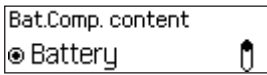
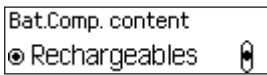
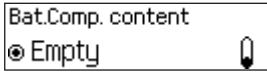
| Display   | Power supply type   |
|---|---|
|  | <p><b>Batteries</b> are inserted in the battery compartment.</p> <p>If the locking system is connected to an external voltage source, the batteries serve as backup in case of power failure. <b>No charging current flows.</b></p>   |
|  | <p>A <b>rechargeable battery pack</b> is inserted in the battery compartment.</p> <p>If the locking system is connected to an external voltage source, the batteries serve only as backup in case of power failure. During operation, the battery pack is recharged constantly. The * symbol in the display indicates the charging process.</p> |
|  | <p>The <b>battery compartment is empty.</b></p>   |



#### Danger of explosion

Alkaline and lithium batteries may be not charged because they can explode during charging and thus injure persons or damage property.

Therefore, **never set the supply to "Battery" when alkaline or lithium batteries are inserted in the battery compartment** and the system is connected to an external power supply, since if set to "Rechargeable battery" a charging current flows to the battery compartment during operation.

**Authorization: Master Code "MA1"**

**Requirement: System status "Unlocked"** (door locks and door bolt open)

To correct the battery compartment content, proceed as follows:

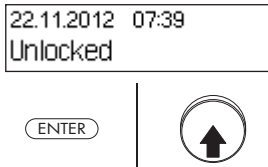
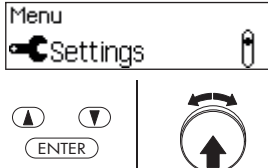
|   |   |
|---|---|
| <p>1. Wake up display (if necessary) and access menu.</p> |  |
| <p>2. Select and confirm the menu option "Settings".</p>  |  |

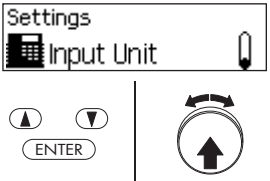
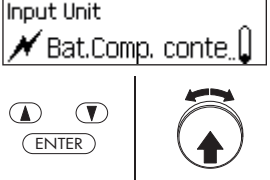
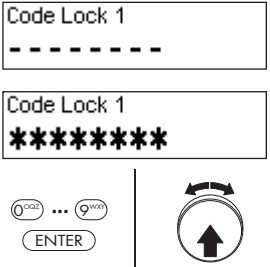
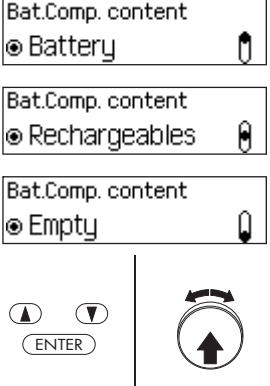
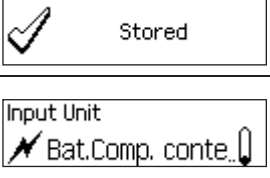
|  |   |
|--|---|
| <p>3. Select and confirm menu option “<b>Settings Input Unit</b>”.</p>   |    |
| <p>4. Select and confirm menu option “Input unit bat.comp. content”.</p>   |    |
| <p>5. Enter and confirm Master Code of lock 1.</p>   |    |
| <p>Batteries inserted in the battery compartment</p> <p>Rechargeable battery pack inserted in the battery compartment</p> <p>Battery compartment empty</p> <p>6. Set battery compartment content according to the actual situation on the ground and confirm.<br/>Note: It is essential here to observe the information provided at the start of this section.</p> |   |
| <p>The setting is stored.</p> <p>The input unit returns to the menu option “Input Unit bat.comp content”. You can now configure other settings or return to the standard mode display.</p>   |  |

## 6 Querying System Information

### 6.1 Querying system information over the Info menu

#### 6.1.1 Accessing the Info menu

In the Info menu you can query information about the system settings, the locks, the input unit, the I/O-Box (option) and the I/O-Box (option). See *section 9.1.2* for an overview of the Info menu.

**Authorization: No code needed**

To access the Info menu, proceed as follows:

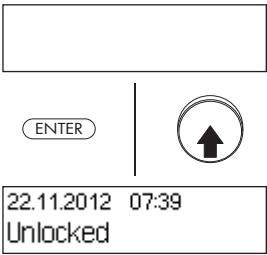
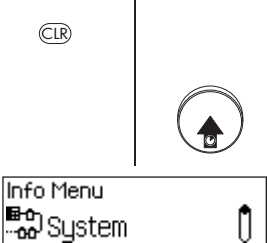
|  |  |
|--|--|
| <p>1. Wake up display.</p>   |   |
| <p>2. <b>Keypad input unit:</b> press and hold down &lt;CLR&gt; key. Release key as soon as the Info menu appears.<br/> <b>Dial knob input unit:</b> press and hold down dial knob. Release dial knob as soon as the Info menu appears</p> <p>The first menu option ("System") of the Info menu appears.</p> |  |

### 6.1.2 Querying the system settings

**Authorization: No code needed**

To query the system settings, proceed as follows:

1. Wake up display (if necessary) and access the Info menu (see section 6.1.1 "Accessing the Info menu").

2. Select and confirm menu option "System".

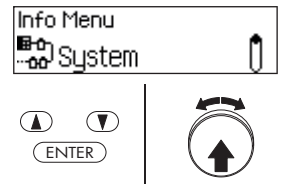

The following system settings can now be queried using the arrow keys or by turning the knob.

- Designated code format ("PIN" or "ID+PIN")
- Status Parallel Mode ("On" or "Off")
- Supply of system ("Battery", "Accumulator" or "Empty")
- Location of the voltage source ("Input Unit" for battery operation, "I/O-Box" or "IP-Box" with external supply)
- Current Bus voltage

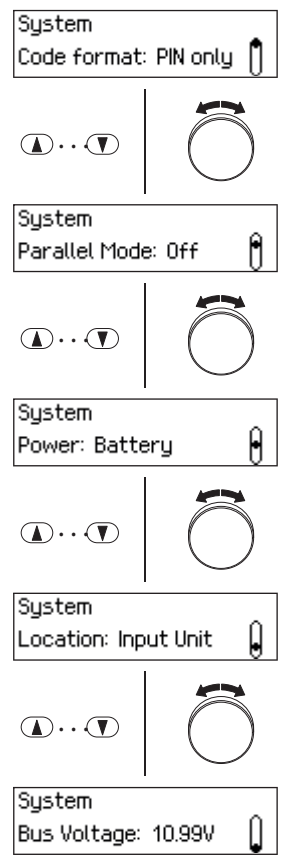

### 6.1.3 Querying lock information

**Authorization: No code needed**

To query the information of a lock, proceed as follows:

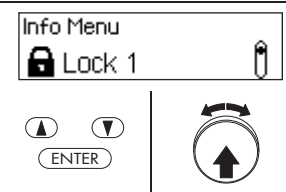
|   |   |
|---|---|
| <ol style="list-style-type: none"> <li>1. Wake up display (if necessary) and access the Info menu (see section 6.1.1 "Accessing the Info menu").</li> </ol> |  |
| <ol style="list-style-type: none"> <li>2. Select the desired lock whose settings you want to view and confirm.</li> </ol>                                   |   |

The following information about the selected lock can be queried using the arrow keys or by turning the dial knob.

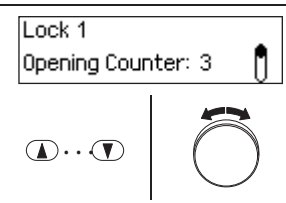
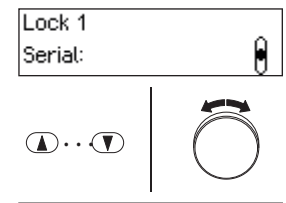
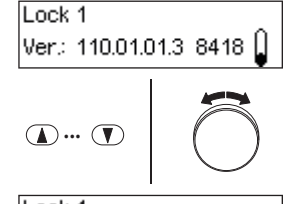
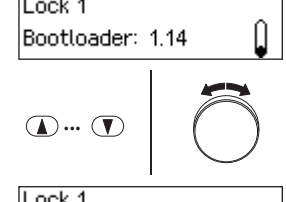
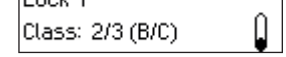
|  |   |
|--|---|
| <ul style="list-style-type: none"> <li>- Current status of the opening counter</li> </ul>      |    |
| <ul style="list-style-type: none"> <li>- Serial number of the lock</li> </ul>                  |   |
| <ul style="list-style-type: none"> <li>- Firmware version of the lock</li> </ul>               |  |
| <ul style="list-style-type: none"> <li>- Bootloader version of the lock</li> </ul>             |  |
| <ul style="list-style-type: none"> <li>- Lock class according to EN 1300 / VdS 2396</li> </ul> |  |



### 6.1.4 Querying information of an input unit

**Authorization: No code needed**

To query the information of an input unit, proceed as follows:

1. Wake up display (if necessary) and access the Info menu (see section 6.1.1 "Accessing the Info menu").

2. Select and confirm menu option "Input Unit".

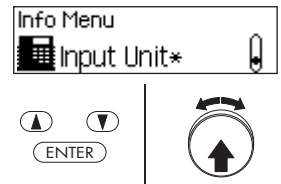

The following information about the input unit can be queried using the arrow keys or by turning the dial knob.

- Serial number of the input unit
- Firmware version of the input unit
- Bootloader version of the Input unit
- Content of battery compartment ("Comp. Cont.: Battery" (Battery), "Comp. Cont.: Recharg." (Accumulator) or "Comp. Cont.: Empty" (Empty))
- Charging status of the batteries or the rechargeable battery pack
- Indication of whether charging current is flowing ("Charging active: Yes ") or not ("Charging active: No")

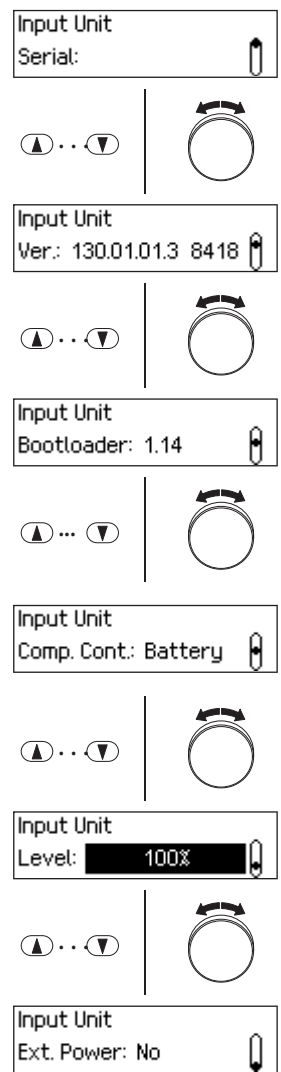

### 6.1.5 Querying information on the I/O-Box

**Authorization: No code needed**

To query the information of the I/O-Box, proceed as follows:

1. Wake up display (if necessary) and access the Info menu (see section 6.1.1 "Accessing the Info menu").

2. Select and confirm menu option "I/O-Box".

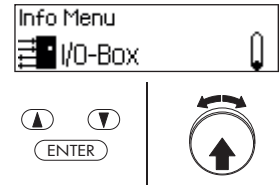

The following information about the I/O-Box can be queried using the arrow keys or by turning the dial knob.

- Serial number of the I/O-Box
- Firmware version of the I/O-Box
- Bootloader version of the I/O-Box
- Current internal voltage of the I/O-Box

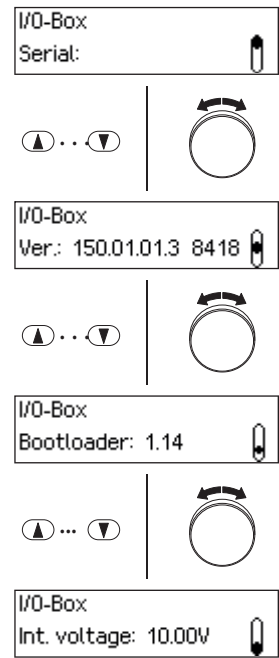

### 6.1.6 Querying information on the IP-Box

**Authorization: No code needed**

To query the information of the IP-Box, proceed as follows:

1. Wake up display (if necessary) and access the Info menu (see section 6.1.1 "Accessing the Info menu").

2. Select and confirm menu option "IP-Box".

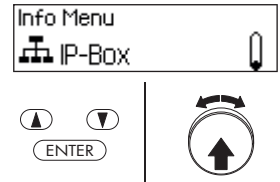

The following information about the IP-Box can be queried using the arrow keys or by turning the dial knob.

- Serial number of the IP-Box
- Firmware version of the IP-Box
- Bootloader version of the IP-Box
- Current internal voltage of the IP-Box
- Current IP network identification setting of the IP-Box

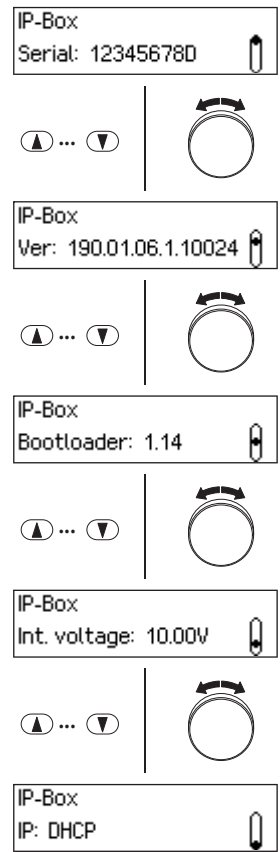



## 6.2 Querying locking periods

In the system status “Secured” (door bolt and door locks closed) you can query at any time via the Secured menu a list of the specified locking periods (Holiday Locking Periods, Weekly Locking Periods, etc.).

**Authorization:** Each code of lock 1

**Requirement:** System status “Secured”

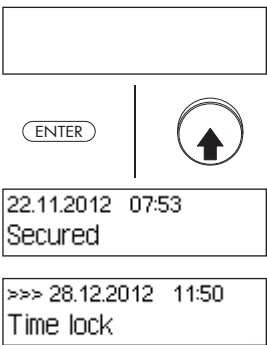
To retrieve the list of Locking Periods, proceed as follows:

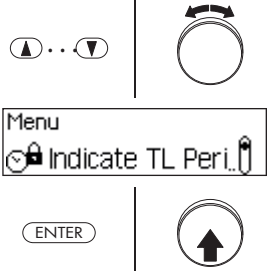
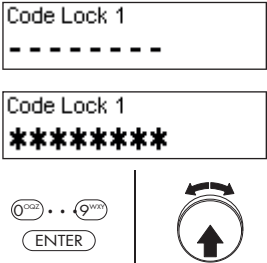
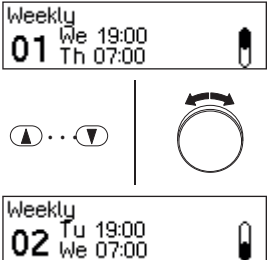
|  |   |
|--|---|
| <p>1. Wake up display.</p> <p>The current system status is displayed:</p> <ul style="list-style-type: none"> <li>– “Secured”: No Locking Period active.</li> <li>– “Locking Period”: Locking Period active.</li> </ul> |    |
| <p>2. Access menu (Secured menu).</p>  |   |
| <p>3. Select menu option “Query Locking Period” and confirm.</p>   |  |
| <p>4. Enter and confirm any code of lock 1.</p>  |  |
| <p>You can now query all pre-defined locking periods by using the arrow keys or turning the dial knob. Each type of Locking Period and the start and end time of the Locking Period are displayed.</p>                 |  |

## 7 Maintenance

### 7.1 Notes on maintenance

Except for the occasional cleaning of the input unit and replacement of the batteries or rechargeable battery pack, the locking system does not require special maintenance.

The change of system components may be executed for warranty purposes only by an authorized dormakaba trained business partner.

### 7.2 Cleaning the input unit

If necessary, clean the outside of the input unit with a cloth moistened with a mild detergent.



#### CAUTION

The input unit may be damaged by aggressive detergents or liquid penetration.

- Do not use abrasive cleaners or cleaning products containing solvents or other aggressive substances.
- Make sure that no liquids come into contact with the input unit.

### 7.3 Replacing the batteries/dormakaba rechargeable battery pack, Battery code

The batteries or dormakaba rechargeable battery pack must be replaced as soon as the “Low battery” message appears.

Low battery

To change the battery, proceed as follows:

1. Carefully unlock the latch of the battery holder with a finger, then remove the battery holder from the input unit downwards diagonally.

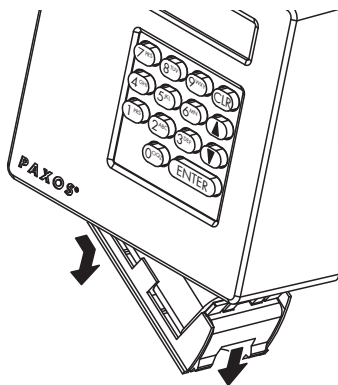

*Removing the battery holder*

2. Remove battery pack or dormakaba rechargeable battery pack from the battery holder.

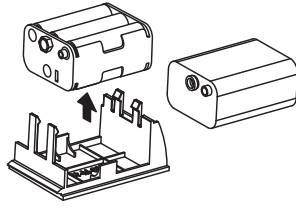

*Removing the battery pack / dormakaba rechargeable battery pack*

3. Replace the old batteries (six 1.5-volt alkaline batteries or 1.5 volt lithium batteries type AM3, AA) by six new batteries of the same type. When inserting the new batteries, **observe correct polarity** (see polarity markings in the battery receptacles).

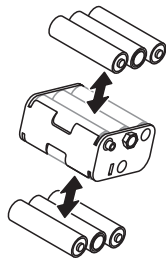

*Replacing batteries*

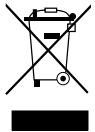

**Professionally dispose of used batteries/rechargeable batteries**

Used batteries/rechargeable batteries are to be disposed or taken to a recycling point, in accordance with state and local regulations. Under no circumstances may batteries be disposed of in the household waste or environment.

Carefully store the batteries/dormakaba rechargeable battery packs to be disposed of in order to avoid short circuits, squeezing, or destruction of the battery/rechargeable battery casing.

4. Insert battery pack and dormakaba rechargeable battery pack in the battery holder.

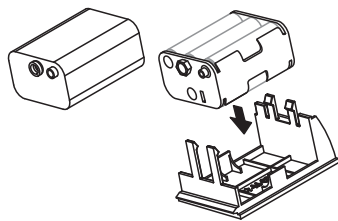

*Inserting the battery pack / dormakaba rechargeable battery pack*



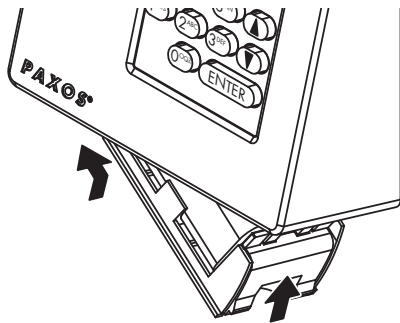

- Carefully insert battery holder into the input unit as shown below (the battery holder must snap into the input unit).



*Mounting the battery holder*



Make sure to insert the battery holder in the right direction else the input unit will be damaged!

|   |  |
|---|--|
| <p>Once the batteries or the battery pack are inserted or the external power supply is switched on, a test program is started. The adjacent displays appear successively. The final display will show that the battery compartment was open and the type of battery inserted in the compartment.</p>  | <div style="border: 1px solid black; padding: 5px; text-align: center;">  </div> <div style="border: 1px solid black; padding: 5px; text-align: center; font-weight: bold; font-size: 1.2em;">                 PAXOS             </div> <div style="border: 1px solid black; padding: 5px; text-align: center;">                 Batt. comp. opened,<br/>Batteries inside             </div>  |
| <p>6. Check and confirm display of the battery compartment contents.<br/>Note: Should for any reason the indicated battery content not match the actual content, set the correct battery content immediately after entering the Battery Code (see section 5.4.3.3 "Setting the content of the battery compartment").</p>  | <div style="display: flex; justify-content: space-between; align-items: center;"> <div style="border: 1px solid black; padding: 5px; border-radius: 10px;">ENTER</div> <div style="border: 1px solid black; border-radius: 50%; padding: 10px; text-align: center;">  </div> </div>   |
| <p>7. Confirm display "Battery code".</p>   | <div style="border: 1px solid black; padding: 5px;">                 22.11.2012 10:20<br/>Battery code             </div> <div style="display: flex; justify-content: space-between; align-items: center; margin-top: 5px;"> <div style="border: 1px solid black; padding: 5px; border-radius: 10px;">ENTER</div> <div style="border: 1px solid black; border-radius: 50%; padding: 10px; text-align: center;">  </div> </div>  |
| <p>8. Enter and confirm Master Code, Mutation Code, Time Code, or OCa1 and another opening code of lock 1.<br/>Note: if the locking system contains more than one input unit, the battery code must be input on all input units, otherwise the locking system cannot be opened. If an input unit is located inside the safe, the opening must be done via the Service menu.</p> | <div style="border: 1px solid black; padding: 5px;">                 Code Lock 1<br/>-----             </div> <div style="border: 1px solid black; padding: 5px; margin-top: 5px;">                 Code Lock 1<br/>*****             </div> <div style="display: flex; justify-content: space-between; align-items: center; margin-top: 5px;"> <div style="border: 1px solid black; padding: 5px; border-radius: 10px;">ENTER</div> <div style="border: 1px solid black; border-radius: 50%; padding: 10px; text-align: center;">  </div> </div> |
| <p>The current operating status is displayed: The battery replacement process is completed.</p>   | <div style="border: 1px solid black; padding: 5px;">                 22.11.2012 07:39<br/>Unlocked             </div>  |



After battery change imperatively check the time displayed and set it correctly if necessary.

## 8 Operating errors

### 8.1 Error messages / Troubleshooting

In the following table you will find error messages that may appear while operating the locking system as well as information on the locking system component(s) affected by the fault, the cause of the fault, as well as advice on how to eliminate the fault.

We generally recommend that the locking system should be checked by a authorized business partner when errors occur.

| Error number   | Description   | Details/Remedy   |
|----------------|---|--|
| <b>10xx</b>    | <b>Problem with the addressing sequence</b>   |  |
| 1000           | <ul style="list-style-type: none"> <li>– System was addressed</li> <li>– Sequence of the components was modified</li> </ul> | <ul style="list-style-type: none"> <li>– New addressing necessary</li> </ul>   |
| <b>11xx</b>    | <b>Addressing problem</b>   |  |
| 1100           | <ul style="list-style-type: none"> <li>– One component could not be found when addressing</li> </ul>                        | <ul style="list-style-type: none"> <li>– Check wiring and correct if necessary</li> <li>– Check fuses in input unit and replace if necessary</li> <li>– Re-address system</li> </ul>   |
| <b>12xx</b>    | <b>Communication problem</b>  |  |
| 1200 -<br>1201 | <ul style="list-style-type: none"> <li>– One or more components do not answer</li> </ul>                                    | <ul style="list-style-type: none"> <li>– Check wiring and correct if necessary</li> <li>– Check fuses in input unit and replace if necessary</li> <li>– Disconnect batteries and externals power supply for 10 minutes</li> <li>– Restart system</li> </ul>                                  |
| 1220           | <ul style="list-style-type: none"> <li>– See also general error 1200 -&gt; concerns particularly the I/O-Box</li> </ul>     | <ul style="list-style-type: none"> <li>– Check wiring to I/O-Box and correct if necessary</li> <li>– Re-address system</li> <li>– Disconnect Bus and power supply to I/O-Box and reconnect</li> </ul>  |
| 1230           | <ul style="list-style-type: none"> <li>– See also general error 1200 -&gt; concerns particularly the IP-Box</li> </ul>      | <ul style="list-style-type: none"> <li>– Check wiring to IP-Box and correct if necessary</li> <li>– Re-address system</li> <li>– Disconnect Bus and power supply to IP-Box and reconnect</li> </ul>  |
| <b>13xx</b>    | <b>General locking bolt error</b>   |  |
| 1300           | <ul style="list-style-type: none"> <li>– The time of 8 seconds was exceeded when closing</li> </ul>                         | <ul style="list-style-type: none"> <li>– Check bolt work and movement of locking bolt</li> <li>– The maximum force of the lock of 30N may not be exceeded</li> <li>– Check locking bolt path</li> </ul>  |
| 1310           | <ul style="list-style-type: none"> <li>– The time of 8 seconds was exceeded when opening</li> </ul>                         | <ul style="list-style-type: none"> <li>– Locking bolt jammed -&gt; check</li> <li>– Limit switch are not detected</li> <li>– Check closing time with removed lock</li> <li>– If possible and necessary, limit bolt path with adjusting screw</li> <li>– Replace lock if necessary</li> </ul> |
| 1320           | <ul style="list-style-type: none"> <li>– Lock control error</li> </ul>  | <ul style="list-style-type: none"> <li>– Try again</li> <li>– Disconnect system from all supplies and restart</li> <li>– Immediately replace lock</li> </ul>   |
| 1330           | <ul style="list-style-type: none"> <li>– Limit switch(es) was/were not detected</li> </ul>                                  | <ul style="list-style-type: none"> <li>– Lock is/was open and was possibly opened via the Service menu</li> <li>– Replace lock if necessary</li> </ul>   |
| 1340           | <ul style="list-style-type: none"> <li>– Error of the motor when closing</li> </ul>   | <ul style="list-style-type: none"> <li>– Try again</li> <li>– Check for correct movement locking bolt and bolt work</li> <li>– Replace lock if necessary</li> </ul>  |



|                       |  |   |
|-----------------------|--|---|
| 1350                  | – Error of the motor when closing  | – Try again<br>– Check for correct movement locking bolt and bolt work<br>– Replace lock if necessary   |
| <b>14xx,<br/>15xx</b> | <b>Problems with the lock bolt contacts</b>  |   |
| 1400                  | – Error of the lock bolt contacts when opening                                     | – See 1310  |
| 1500                  | – Error of the lock bolt contacts when closing                                     | – See 1300  |
| <b>16xx</b>           | <b>Problems with the door bolt contacts</b>  |   |
| 1620                  | – In secured status the status of the door bolt contacts have changed unexpectedly | – Check wiring and door bolt contacts   |
| <b>17xx</b>           | <b>Redundancy problem</b>  |   |
| 1700 -<br>1701        | – Problems with redundant system components  | – The redundant components have reacted and answered differently<br>– If time functions are affected: Delete last time locking and reenter time locking<br>– If code functions are affected: Delete appropriate code(s) and reenter code(s)<br>– If problem cannot be resolved, reset system. |
| <b>18xx,<br/>19xx</b> | <b>Problem with batteries/rechargeable battery pack</b>                            |   |
| 1800                  | – Batteries/rechargeable battery pack discharged                                   | – Charge of the Batteries/rechargeable battery pack is low<br>– Replace if necessary  |
| 1900                  | – Batteries/rechargeable battery pack are flat                                     | – Charge of the Batteries/rechargeable battery pack is very low<br>– Replace if necessary   |
| <b>21xx</b>           | <b>– Addressing problems</b>   |   |
| 2101                  | – Addressing problem Bus A   | – Address(es) could not be saved on Bus A<br>– Wait (10 seconds), then try again<br>– Check wiring  |
| 2102                  | – Addressing problem Bus B   | – Address(es) could not be saved on Bus B<br>– Wait (10 seconds), then try again<br>– Check wiring  |
| 2103                  | – (MIH_ERROR_CAUSE_ADDRESSING__TIMEOUT = 2103)<br>– Timeout during Addressing      | – Addressing not possible<br>– Check wiring<br>– Check fuses in input unit<br>– Replace input unit  |
| 2104                  | – General addressing problem   | – Addressing not possible<br>– Check wiring<br>– Check fuses in input unit<br>– Replace input unit  |
| 2105                  | – Wrong firmware version of installed system component                             | – Check compatibility of the firmware version of the installed system components, update firmware or replace system components if necessary.  |
| 2106                  | – Max. number of locks on Bus exceeded   | – Reduce number of locks on Bus (max. 11 locks per system)  |
| 2107                  | – Max. number of Bus components exceeded   | – By adding a lock the max. number of system components is exceeded (max. 12 per system). Reduce number of components on Bus  |
| 2108                  | – Max. number of input units on Bus exceeded                                       | – Reduce number of input units on Bus (max. 3 input units per system)   |
| 2109                  | – Max. number of components on Bus exceeded  | – By adding an input unit the max. number of system components is exceeded (max. 12 per system). Reduce number of components on Bus   |
| 2110                  | – Max. number I/O / IP-Boxes on Bus exceeded                                       | – Reduce number of I/O / IP-Boxes on Bus (max. 3 I/O-Boxes per system or max. 1 IP-Box per system)  |

|                |   |   |
|----------------|---|---|
| 2111           | – Max. number of components on Bus exceeded                               | – By adding an I/O or IP-Box the max. number of system components is exceeded (max. 12 per system). Reduce number of components on Bus.                     |
| 2113 -<br>2117 | – Addressing error  | – Check wiring  |
| <b>22xx</b>    | <b>Flash memory problem</b>   |   |
| 2200           | – Flash memory Checksum error   | – Disconnect system from all supplies and restart<br>– If problem cannot be resolved, replace lock  |
| <b>23xx</b>    | <b>Reset problem</b>  |   |
| 23xx           | – Error when resetting  | – Disconnect system from all supplies, restart and reset again<br>– If problem cannot be resolved, replace lock   |
| <b>24xx</b>    | <b>Problems with the time synchronisation of the redundant lock parts</b> |   |
| 2400           | – Redundant lock parts have a time deviation of more than three minutes   | – Set actual time of day<br>– If the error occurs again, disconnect system from all supplies and restart<br>– If problem cannot be resolved, replace lock 1 |
| <b>25xx</b>    | <b>Various problems</b>   |   |
| 2501           | – Battery code was not entered and red button on I/O / IP-Box was pressed |   |
| 2502           | – Red button was pressed on a not addressed I/O / IP-Box                  | – Possible manipulation attempt to remove time lock   |
| 2503           | – a not addressed I/O or IP Box was detected                              | – New addressing necessary  |

## 8.2 Notes on troubleshooting

Please note the following information when dealing with faults:

- A fault does not cause a total system failure, since all electronic components in the secured area are redundant (present twice) and the part that is still working automatically takes over the functions.
- It is important to remedy any signalled errors immediately. In the event of a fault always write down the entire fault message (*see section 8.1 "Error messages / Troubleshooting"*) and immediately contact your business partner or your safe provider (address and telephone number are provided on page 2 of this manual).  
Inform the business partner even if the locking system continues to operate normally after there has been an error message.
- If existing faults are not remedied, the opening function of the locks is automatically disabled after the tenth consecutive error message. This disabling can only be cancelled by the business partner. It prevents a total system failure that could result in the container being permanently locked.

## 8.3 Customer Service

Should you encounter any malfunction or operating problems, please contact your authorized business partner or your safe provider.

# 9 Appendix

## 9.1 Menu overviews for input unit

### 9.1.1 Operator menu

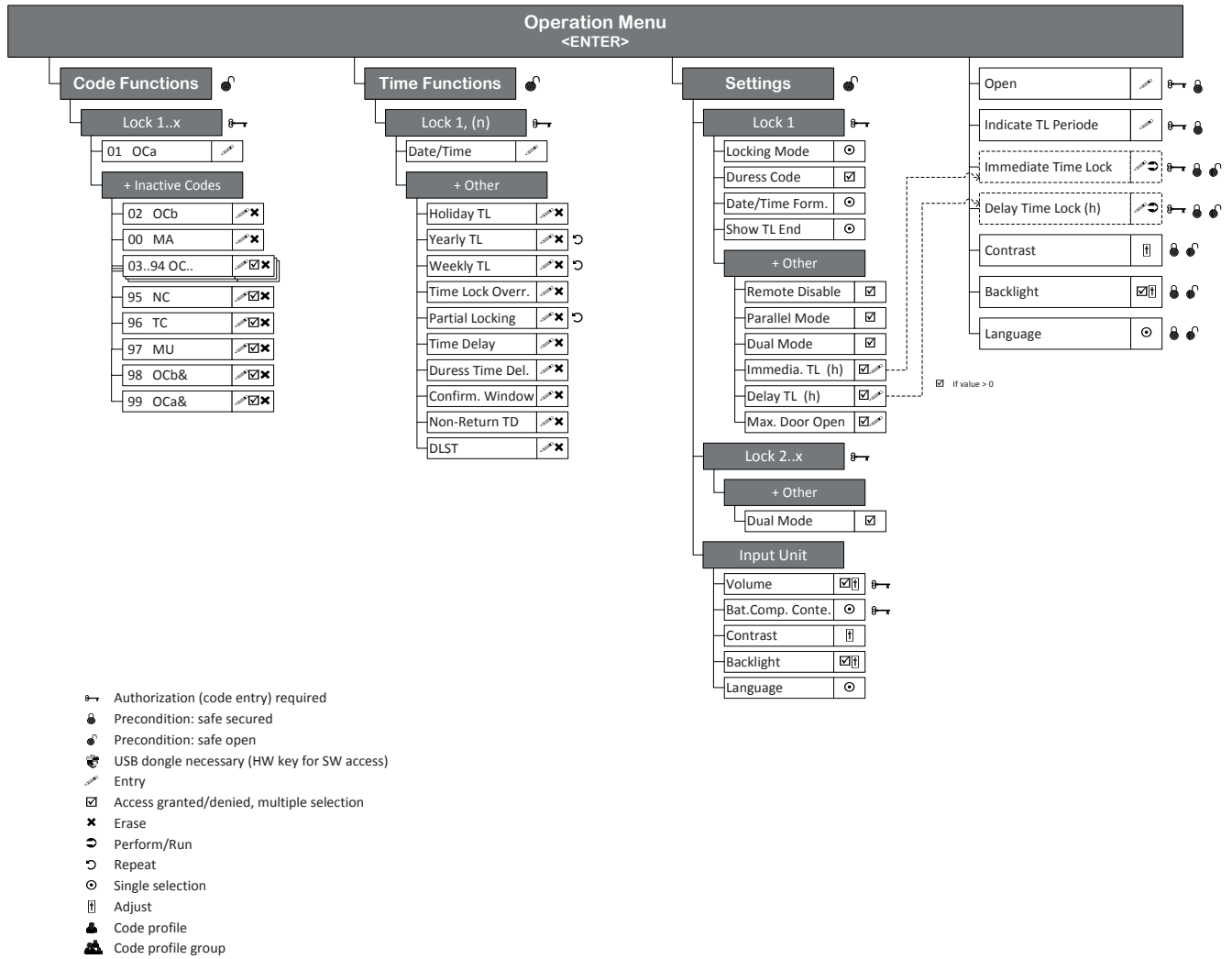

### 9.1.2 Info menu

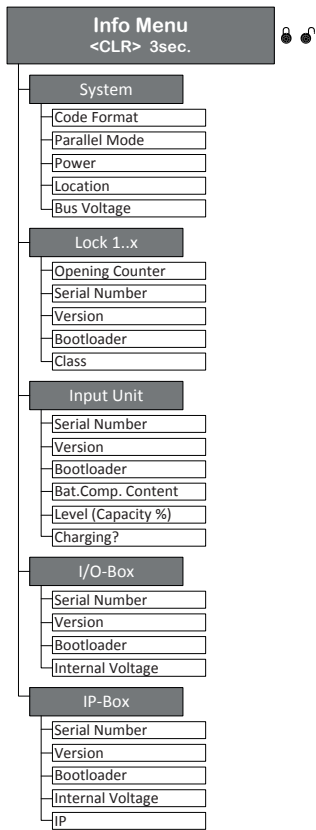

## 9.2 Factory code / Demonstration code list

### 9.2.1 Factory code

Only the Opening Code OCa.. of a lock is enabled ex works and set to the factory code "10203040". (or "0010203040" with ID+PIN mode)



In ID+PIN operation the codes are composed from the corresponding list number and the lock password.

Example based on the demonstration code: opening code OCc for lock 1 = 0311223330

### 9.2.2 Demonstration code list

dormakaba Schweiz AG recommends using uniform codes for demonstration purposes or function checking as listed below. These codes are known, and should under no circumstances be used for actual operation of the locking system.

| Code designation   | List number | Lock 1      | Lock 2      | Lock 3      |
|--------------------|-------------|-------------|-------------|-------------|
| Master Code MA..   | 00          | 11 99 88 77 | 12 99 88 77 | 13 99 88 77 |
| Opening Code OCa.. | 01          | 11 22 33 10 | 12 22 33 10 | 13 22 33 10 |
| Opening Code OCb.. | 02          | 11 22 33 20 | 12 22 33 20 | 13 22 33 20 |
| Opening Code OCc.. | 03          | 11 22 33 30 | 12 22 33 30 | 13 22 33 30 |
| Opening code OCd.. | 04          | 11 22 33 40 | 12 22 33 40 | 13 22 33 40 |
| Opening Code OCe.. | 05          | 11 22 33 50 | 12 22 33 50 | 13 22 33 50 |
| Opening Code OCf.. | 06          | 11 22 33 60 | 12 22 33 60 | 13 22 33 60 |
| Opening Code OCg.. | 07          | 11 22 33 70 | 12 22 33 70 | 13 22 33 70 |
| Opening Code OCh.. | 08          | 11 22 33 80 | 12 22 33 80 | 13 22 33 80 |
| Opening Code OCi.. | 09          | 11 22 33 90 | 12 22 33 90 | 13 22 33 90 |
| Opening Code OCj.. | 10          | 11 22 44 00 | 12 22 44 00 | 13 22 44 00 |
| Opening Code OCk.. | 11          | 11 22 44 05 | 12 22 44 05 | 13 22 44 05 |
| Opening Code OCl.. | 12          | 11 22 44 10 | 12 22 44 10 | 13 22 44 10 |
| Opening Code OCm.. | 13          | 11 22 44 15 | 12 22 44 15 | 13 22 44 15 |
| Opening Code OCn.. | 14          | 11 22 44 20 | 12 22 44 20 | 13 22 44 20 |
| Opening Code OCo.. | 15          | 11 22 44 25 | 12 22 44 25 | 13 22 44 25 |
| Opening Code OCp.. | 16          | 11 22 44 30 | 12 22 44 30 | 13 22 44 30 |
| Opening Code OCq.. | 17          | 11 22 44 35 | 12 22 44 35 | 13 22 44 35 |
| Opening Code OCr.. | 18          | 11 22 44 40 | 12 22 44 40 | 13 22 44 40 |
| Opening Code OCs.. | 19          | 11 22 44 45 | 12 22 44 45 | 13 22 44 45 |
| Opening Code OCt.. | 20          | 11 22 44 50 | 12 22 44 50 | 13 22 44 50 |
| Opening Code OCu.. | 21          | 11 22 44 55 | 12 22 44 55 | 13 22 44 55 |
| Opening Code OCv.. | 22          | 11 22 44 60 | 12 22 44 60 | 13 22 44 60 |
| Opening Code OCw.. | 23          | 11 22 44 65 | 12 22 44 65 | 13 22 44 65 |
| Opening Code OCx.. | 24          | 11 22 44 70 | 12 22 44 70 | 13 22 44 70 |
| Opening Code OCy.. | 25          | 11 22 44 75 | 12 22 44 75 | 13 22 44 75 |
| Opening Code OCz.. | 26          | 11 22 44 80 | 12 22 44 80 | 13 22 44 80 |
| Time Code TC..     | 96          | 11 99 88 55 | 12 99 88 55 | 13 99 88 55 |
| Mutation Code MU.. | 97          | 11 99 88 66 | 12 99 88 66 | 13 99 88 66 |
| And Code OCb.&     | 98          | 11 22 33 02 | 12 22 33 02 | 13 22 33 02 |
| And Code OCa.&     | 99          | 11 22 33 01 | 12 22 33 01 | 13 22 33 01 |

For each additional lock, the first two digits of the corresponding demonstration code for the previous lock are increased by 1.

